

MODEL 2408/INDICATOR**User Manual****Contents**

1	Installing and Operating Instructions	3
1.1	Contents of package	3
1.2	Dimensions and Installation	3
1.2.1	To Install the Indicator	3
1.2.2	Removing The Indicator From The Sleeve	3
1.3	New Sleeve Design MkIII	4
1.3.1	Details	4
1.3.2	Reasons for the Change	4
1.3.3	Recommendations.....	4
1.4	Electrical Connections	5
1.4.1	Wiring	5
1.4.2	Plug-in Module Connections	5
1.4.3	Communications Modules	5
2	Operation.....	6
2.1.1	To View The Display Units.....	6
2.1.2	Home Display Options.....	6
2.2	Alarms	7
2.2.1	Types of Alarm Used In The 2408i.....	7
2.2.2	Alarm Relay Output	7
2.2.3	Alarm Indication.....	8
2.2.4	Alarm Messages.....	8
2.2.5	Diagnostic Alarms.....	9
2.2.6	To Acknowledge An Alarm	9
2.2.7	Alarm Inhibit	9
2.2.8	To Change The Alarm Setpoints (trip levels)	10
2.3	Auto-Tare (Display Zero).....	11
2.3.1	To Use Auto Tare	11
2.4	To Access and Change Parameter Values	12
2.4.1	Operator Level Navigation Diagram (factory default).....	12
2.5	Parameter tables.....	13
2.5.1	HOME List	13
2.5.2	Alarm List.....	13
2.5.3	Setpoint List	13
2.5.4	Input List	14
2.5.5	User Calibration Lists - Inputs 1 and 2	14
2.5.6	Access List.....	14
3	Password Protected Levels of Operation	15
3.1	Access levels	15
3.1.1	To Select Full or Edit Access Levels.....	15
3.2	Navigation Diagram (full and edit levels).....	16
3.3	Parameter Tables.....	18
3.3.1	HOME List	18
3.3.2	Alarm List.....	18
3.3.3	Setpoint List	18
3.3.4	Input List	19
3.3.5	User Calibration Lists	20
3.3.6	Custom Linearisation List 1 or 2	23
3.3.7	Digital Communications List	24
3.3.8	Information List.....	24
3.3.9	Access List.....	24
3.4	To Hide, Reveal and Promote Parameters.....	25
3.4.1	List Headers	25
3.4.2	Parameters	25
3.5	Calibration	26
3.5.1	User Calibration	26
3.6	Transducer Calibration	27
3.6.1	Shunt Calibration	27
3.6.2	To Calibrate a Strain Gauge Bridge Transducer	27
3.6.3	Load Cell Calibration	29
3.6.4	To Calibrate a Load Cell	29
3.6.5	Comparison Calibration	30
3.6.6	To Calibrate by Comparison with an External Reference	30
3.6.7	Manual Calibration	31
3.6.8	Auto-Tare or Display Zero	32
3.6.9	To Enter a Fixed Offset to the Tare Value.....	32
3.7	Custom Linearisation	33
3.7.1	Example: To Linearise Input 1	33
3.7.2	Compensation for Sensor Non-Linearities	33

4	CONFIGURATION LEVEL	34
4.1	Hardware configuration - I/O Modules	34
4.2	Software configuration	35
4.2.1	To Select Configuration Access Level	35
4.3	Location of Parameters - From Indicator Block Diagram.....	36
4.4	Navigation diagram (configuration level).....	37
4.5	Configuration Parameter Tables - All indicators.....	38
4.5.1	Instrument configuration list	38
4.5.2	Sensor Input Configuration List.....	39
4.5.3	Alarm Configuration	41
4.5.4	Alarm Inhibit	42
4.5.5	2408i Indicator With Alarm Inhibit Timer.....	43
4.5.6	Digital inputs 1 and 2 Configuration	44
4.5.7	Peak Hold and Sample and Hold	45
4.5.8	Relay Output 1 Configuration.....	46
4.6	Configuration Parameter Tables - plug in modules.....	48
4.6.1	Communications Module.....	48
4.6.2	Communications Parameters.....	48
4.6.3	PDS input Module.....	48
4.6.4	DeviceNet Communications	50
4.6.5	Module 1, 2 and 3 Configuration Lists	51
4.6.6	Changeover Relay or Dual Relay Output Module.....	51
4.6.7	Triple Logic Output Module	51
4.6.8	Triple Logic Input or Triple Contact Closure Input Module	52
4.6.9	DC input Module	53
4.6.10	DC Retransmission Module.....	55
4.6.11	Strain Gauge Transducer Supply	55
4.6.12	Transmitter Power Supply	55
4.7	Indicator calibration	56
4.7.1	To Calibrate Input 1 or 2.....	56
4.7.2	To Calibrate Retransmission Output	57
4.7.3	To Restore Factory Calibration.....	57
4.7.4	Calibration Parameters	58
4.7.5	Password Configuration	58
4.7.6	To Leave Configuration Level	58
5	Ordering Code.....	59
6	Safety and EMC Information	60
7	Technical Specification	61

2408i Indicator and Alarm Unit

1 Installing and Operating Instructions

Thank you for choosing the 2408i panel mounted indicator. It will provide accurate measurement and display of temperature and other process variables. A modular build accepts a wide range of plug-in modules allowing: up to four alarm outputs, two process variable (PV) inputs, direct strain gauge/pressure sensor measurements, custom linearisation, analogue retransmission, remote setpoint (SP) input and digital communications.

The indicator is supplied configured in accordance with the order code. The order code and instrument serial number is shown on a label fixed to the top of the case, and this can be checked against the order code given in section 5 of these instructions.

1.1 Contents of package

1. A peel-off label set - a convenient position is to fix a label to the top right of the display.
2. A 2.49Ω resistor used as the load resistor for a mA input
3. Two panel retaining clips
4. Panel sealing gasket

°C	°F	K	kPa	V	mV
m/s	cm/s	l/h	mWG	A	mA
x10	1x10	l/min	T/h	%	%RH
p.s.i.	bar	mbar	mPas	%pH	pH
p.s.i.x10	mmHg	Kg/cm ²	gal/min	rev/min	mile/h
					Amps

1.2 Dimensions and Installation

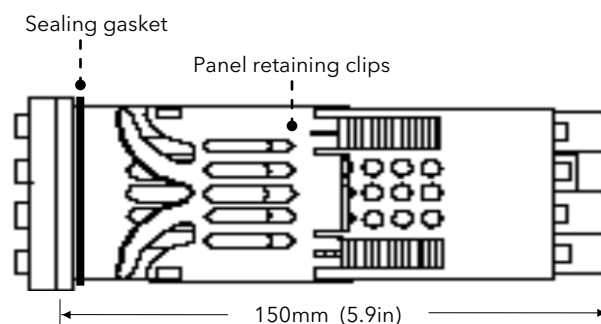
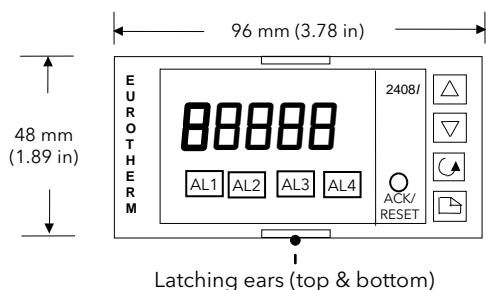

1.2.1 To Install the Indicator

Please read the safety information in section 6 before proceeding.

The indicator is intended to be mounted on a panel within an enclosure such as a control cubicle.

1. Prepare the panel cut-out to the size shown.
2. Fit the sealing gasket behind the front bezel of the instrument.
3. Insert the indicator in its sleeve through the cut-out.
4. Spring the panel retaining clips into place. Secure the indicator in position by holding it level and pushing both retaining clips forward.
5. Peel off the plastic film protecting the front of the indicator.

Panel cut-out

92	X	45 mm
-0.0 +0.8		-0.0 +0.6
3.62	X	1.77 in
0.0 +0.03		-0.0 +0.02

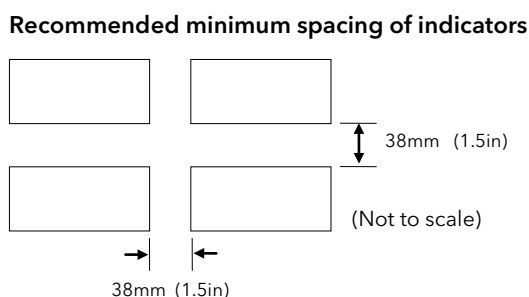

1.2.2 Removing The Indicator From The Sleeve

! The indicator can be removed from its sleeve by easing the latching ears outwards and pulling it forward out of the sleeve. When plugging the indicator back into its sleeve, ensure that the latching ears click into place to maintain the moisture sealing protection.

It is recommended that power to the controller is turned off when removing or replacing the controller into its sleeve, to prevent premature wear on the connectors when current is flowing through them.

1.3 New Sleeve Design MkIII

From Jan-03 an improved design of 1/8 DIN long sleeve is shipped with all new 2408 controllers and indicators. (The month and year of manufacture are shown in the last two pairs of digits of the instrument serial number).

1.3.1 Details

A new sealing gasket will be fitted onto the instrument bezel ①. This gasket replaces the gasket which was moulded into the front of the sleeve of all previous instruments.

The gasket previously moulded into the sleeve where it fits behind the panel is now supplied as a separate item ②.

1.3.2 Reasons for the Change

This change is to ensure that IP65 sealing is reliably achieved and less physical effort is required to insert the instrument into the new sleeve.

1.3.3 Recommendations

1. An instrument delivered after Jan 03 should be used with the sleeve supplied
2. If the instrument is required to replace one already in use, the existing sleeve should also be replaced
3. A new instrument can be fitted into an existing sleeve by carefully removing gasket ① but IP65 sealing will not be maintained
4. An existing instrument can be fitted into a new sleeve but IP65 sealing will not be maintained

It is, however, possible to achieve IP65 sealing for 3 and 4 above. A gasket kit is available from Eurotherm by quoting Part No SUB24/GAS2408.

Then:-

5. To fit a new instrument in an older sleeve carefully remove gasket ①. Replace it with the thinner (1.25mm) gasket from the kit
6. To fit an existing instrument into a new sleeve fit the thicker (1.6mm) gasket from the kit between the instrument and the sleeve

The seal ② supplied as a separate item with a new instrument, should be placed over the sleeve prior to mounting it through the panel cut out as shown below:-

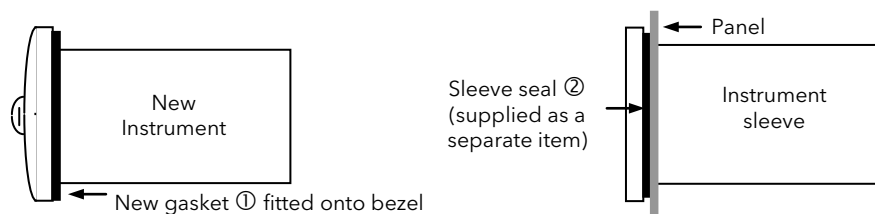

1.4 Electrical Connections

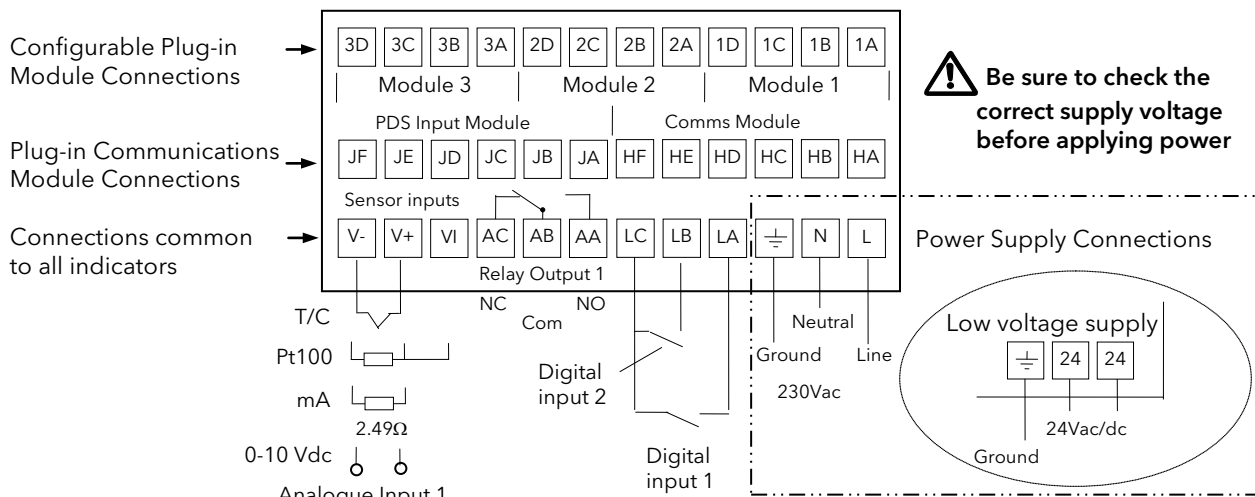

1.4.1 Wiring

The screw terminals accept wire sizes from 0.5 to 1.5 mm² (16 to 22 AWG) and should be tightened to a torque of 0.4Nm (3.5lb in). Hinged terminal covers provide IP20 protection.

1.4.2 Plug-in Module Connections

Modules are fitted in positions 1, 2 and 3 in accordance with the ordering code. The tables below show the connections for each module and the possible functions they can perform.

Note: On the wiring label the module number precedes the terminal identity letter given in the table below. For example, 1A, 1B, 1C.

Module Type	Terminal Identity				Typical Functions
	A	B	C	D	
Relay; changeover					Alarm or Event
Dual relay (normally open)					Alarms or events
DC retransmission	+	-			Analogue retransmission of PV
Transmitter supply 24V	+	-			To power transmitters
Strain Gauge Transducer supply (see note 1)	+	-			To power strain gauges. (5V or 10V selectable)

Module Type	Terminal Identity				Typical Functions
	A	B	C	D	
2nd Analogue Input (Analogue Input 2) (module 3 only)			+	-	Thermocouple
					PRT
			+	-	mA (2.49Ω sense resistor)
			+	-	High impedance 0 - 2.0Vdc millivolts
	+			-	0 - 10Vdc
Triple contact input	ip1	ip2	ip3	Com	
Triple digital input	ip1	ip2	ip3	Com	
Triple digital output	op1	op2	op3		

Notes:-

- By default:
 - The transducer supply for input 1 is installed in module position 2
 - The transducer supply for input 2 is installed in module position 1
- All module connections are isolated from the process value, earth, incoming supply and connections to other modules.
- Digital inputs are non-isolated from the process value.
 - Digital inputs are powered by the indicator. Switching voltage and current 24Vdc/20mA.

See Section 7 for specifications and maximum safety limits

1.4.3 Communications Modules

Digital Communications Module					
Module type	Terminal identity				
	HB	HC	HD	HE	HF
RS232	-	-	Com	Rx	Tx
RS485 (2-wire)	-	-	Com	A (+)	B (-)
RS485 (4-wire)	Rx+	Rx-	Com	Tx+	Tx-
Profibus	Shield	VP	B	A	DGND

PDS Module			
Setpoint Input	Terminal identity		
	JD	JE	JF
	-	Signal	Common

2 Operation

Switch on the indicator. After a 3 second self-test sequence, you will see the display shown below. This is called the 'HOME' display.

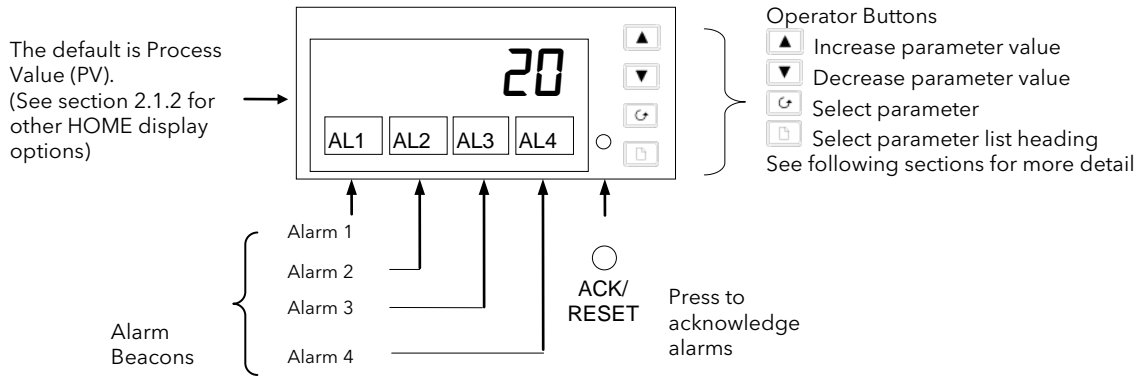

2.1.1 To View The Display Units

If the indicator has been configured for a thermocouple or RTD input, the temperature units can be viewed as follows:

Do This	This Is The Display You Should See	Additional Notes
1. Press and quickly release the or button.		<p>Display Units</p> <p>°C Celsius OR °F Fahrenheit OR °K Kelvin</p> <p>The display units are shown for 0.5 second</p> <p>Note: For linear inputs no units are displayed. In this case:</p> <p>Press to go directly to the d, SP display - see section 2.1.2.</p> <p>Press to go directly to the AL List - see section 2.2.4.</p>

2.1.2 Home Display Options

When shipped from the factory the HOME display will show the measured temperature or process value. This is the 'front' display.

If either or is pressed the display changes to the 'back' display for a period of two seconds. The back display can show an alternative measurement, such as alarm setpoint or second PV input value.

Do This	This Is The Display You Should See	Additional Notes
<p>Example</p> <p>1. From the HOME display, press or .</p> <p>2. Press or again to adjust the Alarm Setpoint between hi & lo limits</p>	<p>'back' display = Alarm setpoint.</p> <p>'front' display = Process Value</p>	<p>Parameters which can be allocated to the Front and Back displays</p> <ul style="list-style-type: none"> <nonE> The HOME display will be blank and only alarm messages will be flashed <SP> Setpoint (for deviation alarms) <rm.SP> Remote setpoint (for deviation alarms) <PUHi > Displays the maximum value on input 1 <PULo> Displays the minimum value on input 1 <PU> Process Value <AL.SP> Alarm 1 setpoint <L 1> Linearised input 1 <L 2> Linearised input 2 <p>Note:</p> <p>If the indicator has been ordered to read the highest (order code HI) or lowest values (order code LO) between input 1 and 2, the display shows only this value.</p> <p>If PV function ordered as FN, the displayed reading will be derived from inputs 1 and 2.</p> <p>The back display is not selectable in this mode</p>



Pressing and together will always return to the HOME display.

OR

The display will always return to the HOME display if no button is pressed within 45 seconds.

This time is reduced to 10 seconds if an alarm is being displayed.

2.2 Alarms

Alarms are used to alert an operator when a pre-set level has been exceeded. They are normally used to switch an output (see section 2.2.2.) - usually a relay - to provide external actions to the process.

Soft Alarms are indication only and do not operate an output.

Events are generally defined as conditions, which occur as part of the operation of the plant. They do not require operator intervention and, therefore, do not cause an alarm message to be displayed. They can be attached to operate an output (relay) in the same way as an alarm.

2.2.1 Types of Alarm Used In The 2408i

This section shows graphically the operation of different types of alarm used in the indicator. The graphs show changes in PV plotted against time. The PV may be derived from input 1, input 2 or the main PV which is derived from input 1 & 2.

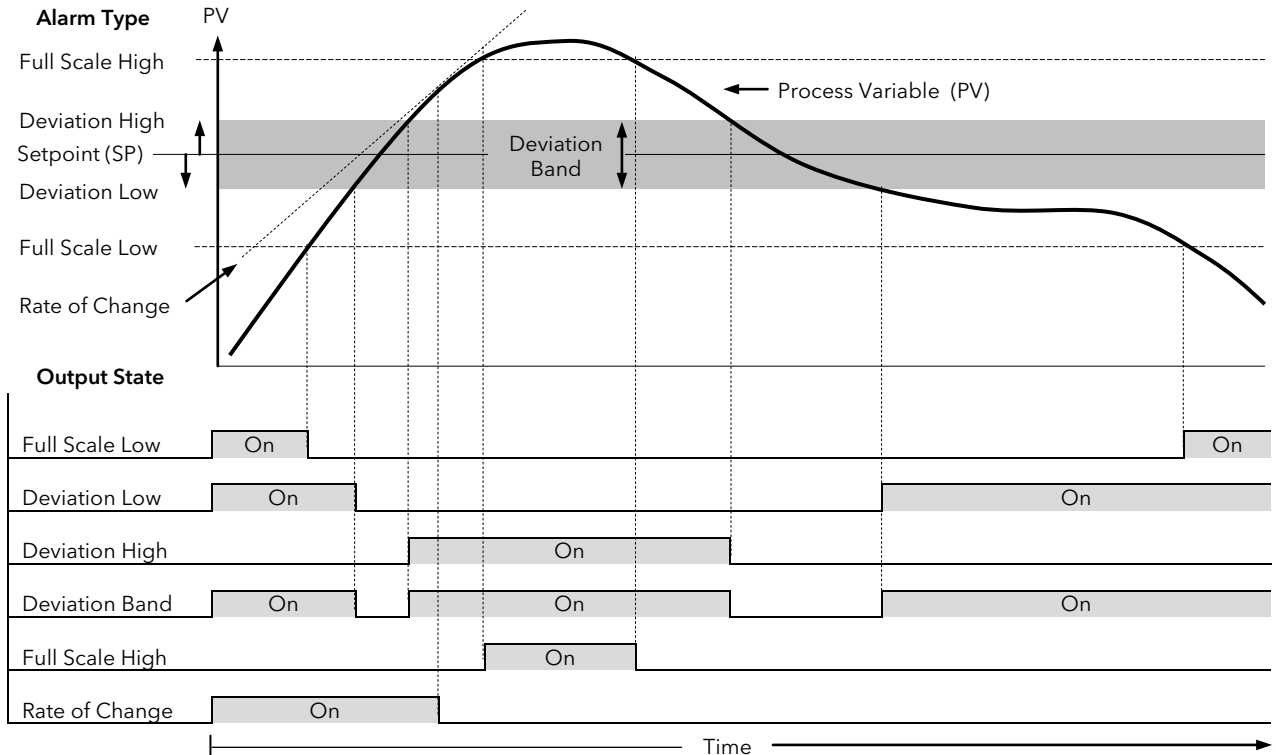

Rate of change alarms detect if the rate of change in PV, set as units per minute or per second, exceeds the setpoint value. An alarm setpoint set + will detect positive rates of change. An alarm setpoint set - will detect negative rates of change. Therefore, if it is required to measure the rate of change in both directions then two alarms must be configured. Since rate of change alarms are calculated over a period of time a small delay may be apparent before the alarm is indicated. This is generally only noticeable if the PV changes very quickly.

Hysteresis is the difference between the point at which the alarm switches ON and the point at which it switches OFF.

It is used to prevent relay chatter.

Latching Alarms see 2.2.6

2.2.2 Alarm Relay Output

Alarms can operate a specific relay or logic output. Any individual alarm can operate an individual output or any combination of alarms can operate an individual output. They are either supplied pre-configured in accordance with the ordering code or set up in configuration level.

Deviation Alarms. The setpoint used for deviation alarms is normally derived as a remote input from another device - for example, a temperature controller. The setpoint can also be internally set within the controller - in this case called the local setpoint value.

Delay a settable time between an alarm occurring and it being displayed on the indicator

Blocking Alarms only occur after the start up phase when the alarm has first entered a safe state. The alarm is only indicated the next time it is active. It is used, for example, to ignore start up conditions which are not representative of running conditions.

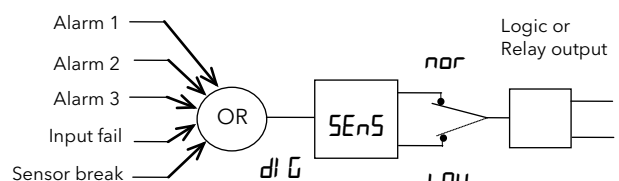

Any combination of alarms can operate the relay or logic output. The diagram shows typical alarms

2.2.3 Alarm Indication

An alarm occurs when the process conditions exceed a pre-set level (setpoint). It will be displayed on the indicator as follows:-

1. The relevant alarm beacon will begin to flash
2. A four character alarm message will be shown as a double repeating flash in the main display. This message specifies the alarm number (first character) and the type of alarm that has occurred (next three characters). The message is flashed in addition to the 'front' displayed value

If more than one alarm is present the relevant beacon illuminates and further messages are flashed in the main display. The alarm indication will continue while the alarm condition is present and is not acknowledged.

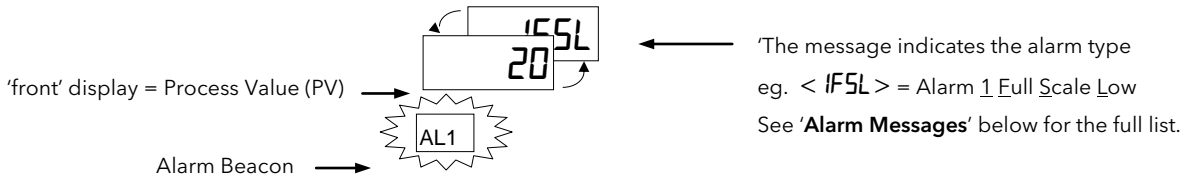

2.2.4 Alarm Messages

Display	Alarm type	Input Source	Alarm description and function	
First character				
1---			Alarm 1 is active	
2---			Alarm 2 is active	
3---			Alarm 3 is active	
4---			Alarm 4 is active	
Last three characters				
-FSL	Full Scale Low	Main PV	The process value is:-	below the low alarm setting on the main PV
-FL 1		PV 1		below the low alarm setting on PV 1
-FL 2		PV 2		below the low alarm setting on PV 2
-FSH	Full Scale High	Main PV		above the high alarm setting on the main PV
-FH 1		PV 1		above the high alarm setting on PV 1
-FH 2		PV 2		above the high alarm setting on PV 2
-dLo	Deviation Low	Main PV		below the low deviation setting on main PV
-dL 1		PV 1		below the low deviation setting on PV1
-dL 2		PV 2		below the low deviation setting on PV2
-dHi	Deviation High	Main PV		above the high deviation setting on main PV
-dH 1		PV 1		above the high deviation setting on PV1
-dH 2		PV 2		above the high deviation setting on PV2
-dEu	Deviation Band	Main PV		above or below the high and low deviation setting on main PV
-du 1		PV 1		above or below the high and low deviation setting on PV1
-du 2		PV 2		above or below the high and low deviation setting on PV2
-rRt	Rate of change (minutes)	Main PV		changing faster than the rate-of change alarm setting in minutes for main input.
-rRS	Rate of change (seconds)	Main PV		changing faster than the rate-of change alarm setting in seconds for main input.
-rt 1	Rate of change (minutes)	Input 1		changing faster than the rate-of change alarm setting in minutes for input 1.
-rs 1	Rate of change (seconds)	Input 1		changing faster than the rate-of change alarm setting in seconds for input 1.
-rt 2	Rate of change (minutes)	Input 2		changing faster than the rate-of change alarm setting in minutes for input 2.
-rs 2	Rate of change (seconds)	Input 2		changing faster than the rate-of change alarm setting in seconds for input 2.
-LSP	Setpoint Low	Main PV	The setpoint is:-	below the low alarm setting
-HSP	Setpoint High	Main PV		above the high alarm setting
Sbr				Sensor Break alarm (open circuit input on whichever input is being used as the PV)



If the **process value flashes** but no other alarm message is displayed, this indicates that the input which is being used as the PV is out of range.



2.2.5 Diagnostic Alarms

In addition to the process alarms given in the previous column the following diagnostic alarms may also appear. These warn that a fault exists in either the indicator or the connected devices.

Alarm	What it means	What to do about it
<i>EEEr</i>	<i>Electrically Erasable Memory Error: The value of an operator or configuration parameter has been corrupted.</i>	This fault will automatically select configuration level. Check all configuration parameters before returning to operator level. Once in operator level, check all operator parameters before resuming normal operation. If the fault persists or occurs frequently, return the unit for repair.
<i>LLLL</i>	<i>Out of range low reading</i>	Check the value of the input
<i>HHHH</i>	<i>Out of range high reading</i>	Check the value of the input
<i>Err1</i>	<i>Error 1: ROM self-test fail</i>	Return the indicator for repair
<i>Err2</i>	<i>Error 2: RAM self-test fail</i>	Return the indicator for repair
<i>Err3</i>	<i>Error 3: Watchdog fail</i>	Return the indicator for repair
<i>Err4</i>	<i>Error 4: Keyboard failure. Stuck button, or a button was pressed during power up.</i>	Switch the power off and then on without touching any of the indicator buttons. If the error continues return the unit for repair.
<i>Err5</i>	<i>Error 5: Input circuit failure</i>	Return the unit for repair
<i>HwEr</i>	<i>Hardware error</i> Indication that a module is of the wrong type, missing faulty, or a new module has been fitted.	Check that the correct modules are fitted. Go to configuration mode and set up the required parameter(s). See section 4 for further information.
<i>PwrF</i>	<i>Power failure: The line voltage is too low</i>	Check that the supply is within rated limits
<i>rmIF</i>	<i>Remote input fail</i>	Connect an input device (eg. transducer, thermocouple, mA source) to input 2

2.2.6 To Acknowledge An Alarm

An alarm can be acknowledged in two ways:-

1. Press the ACK/RESET button. (If this does not work it may have been disabled when the indicator was configured).
2. Press  and  together.

The action, which now takes place, will depend on the type of latching, which has been configured

Non Latched Alarms

If the indicator has been configured for non-latching alarms the following action occurs:-

Alarm condition present when the alarm is acknowledged, will be indicated by a single repeating flash of the alarm message and the beacon will continuously illuminate. This state will continue for as long as the alarm condition remains. When the alarm condition disappears the indication will also disappear.

If a relay has been attached to the alarm output, it will operate when the alarm condition occurs and remain in the operated condition until the alarm is acknowledged **AND** it is no longer present.

If the alarm condition disappears before it is acknowledged the alarm indication disappears as soon as the condition disappears.

Latched Alarms

The indicator may have been configured for Automatic or Manual reset. The action which occurs when the acknowledge button is pressed is described below:-

Automatic.

The alarm continues to be active until both the alarm condition is removed **AND** the alarm is acknowledged. The acknowledgement can occur **BEFORE** the alarm condition is removed.

Manual

The alarm continues to be active until both the alarm condition is removed **AND** the alarm is acknowledged. The acknowledgement can only occur **AFTER** the alarm condition is removed.

2.2.7 Alarm Inhibit













If a digital input has been configured for alarm inhibit, then all process alarm indication will be prevented for as long as the input is ON. When the input is turned to OFF any alarms which are active will be displayed. If a delay has been set on the alarm, the delay period will start from the time when the input is turned OFF. If the alarm has been configured as latching the latching action is also inhibited whenever the input is ON. See section 4.5.4 and 4.5.6.

2.2.8 To Change The Alarm Setpoints (trip levels)

Parameters are grouped in 'lists' according to their function. Each list has a heading.

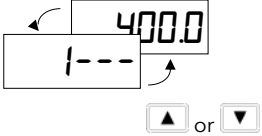
The  button steps through the parameter list headings (see section 2.4.1.)

The first list is the alarm setpoints list *AL*











Do This	This Is The Display You Should See	Additional Notes
<p>1. From any display press  as many times as necessary to show the 'Alarm List' header</p>		<p> If  or  are pressed the word <L, St> is displayed for 2 secs</p> 
<p>2. Press  to show the first parameter in the list</p> <p>3. Press  or  to change the alarm setpoint</p>		<p> There are four alarm setpoints. The first character is the alarm number, the next three the alarm type (see section 2.2.4.)</p> <p>If an alarm has been disabled in configuration level, it will not appear in this list.</p>
<p>4. To return to the HOME display:-</p> <ul style="list-style-type: none"> • Press  and  together • or continue to press  • or the indicator will return to the HOME display if no button is pressed for 45 seconds (10 seconds if an alarm condition is present). 		

2.3 Auto-Tare (Display Zero)

The auto-tare function is used, for example, when it is required to weigh the contents of a container but not the container itself. Alternatively, it can be used to set a fixed offset on an initial measured value.

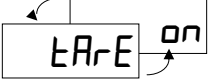
2.3.1 To Use Auto Tare

Place the empty container on the weigh-bridge. Then:-

Do This	This Is The Display You Should See	Additional Notes
1. From any display press  as many times as necessary to show the <CAL 1> List' header		 Use <CAL2> if the load cell is connected to input 2
2. Press  to scroll to <TArE> 3. Press  or  and change from <OFF> to <on>		 The indicator automatically calibrates itself to the empty container. When <TArE> is turned to <on>, the display will change to <buSY>. When calibration is complete the display will return to the HOME display. It will then return to the main display. If the calibration fails the alarm message <tdrF> (transducer fail) will flash. Press  and  to acknowledge.
		

4. Return to the HOME display as described above

Note:-

The indicator will not return to the HOME display until the calibration procedure completes.

If calibration does not complete after a period of 5 minutes, then calibration is aborted.

2.4 To Access and Change Parameter Values

Parameters are settings within the indicator, which determine how it will operate. Examples are Alarm Setpoints and Tare Values already mentioned. They are organised into different lists. Each list has a named heading which describes a particular subject, for example 'Alarms' <AL>

2.4.1 Operator Level Navigation Diagram (factory default)

This list shows the parameters available in operator level in a new instrument.

To find a parameter:-

- Press to select the list heading
 - Press to select the parameter
 - Press or to change its value
- } Examples are shown in sections 2.2.8. and 2.3.1.

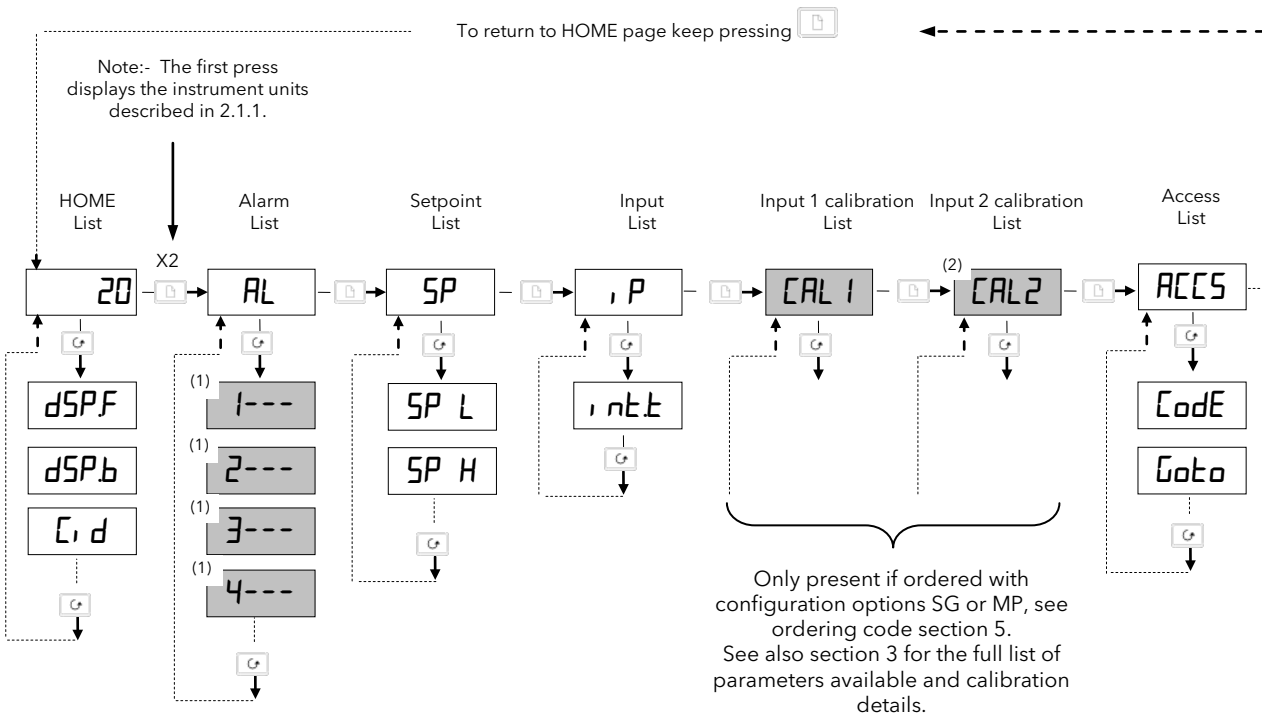

- Blocks shown shaded are dependant upon the order code as follows:-
 - (1) These parameters are only shown if the alarm has been configured
 - (2) CAL2 list is only shown if Input 2 has been configured
- The above list can be customised to suit the requirements of a particular process. Complete lists or individual parameters in a list can be added during commissioning. The procedure is described in section 3.4 'To Hide. Reveal and Promote Parameters'.

2.5 Parameter tables

The parameter tables provide a full list of parameters, an explanation of their use and where to find them.

Use these lists to adjust:-

- The alarm setpoints
- The alarm setpoint limits
- The User calibration
- The input filter time constant
- The communications address

2.5.1 HOME List

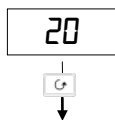

HOME	Home List	Selectable options		Default
dSPF	HOME <u>d</u> isplay <u>f</u> ront	<nonE> <SP> <rm.SP> <PUH> <PULo> <PU> <ALSP> <L1> <L2>	The HOME display will be blank and only alarm messages will be flashed Setpoint (for deviation alarms) Remote setpoint (for deviation alarms) Displays the maximum value on input 1. This parameter is the same as <LOGH> in < nFo > list Displays the minimum value on input 1. This parameter is the same as <LOGL> in < nFo > list Process Value Alarm 1 setpoint Linearised input 1 Linearised input 2	PU
dSPb	HOME <u>d</u> isplay <u>b</u> ack			
C, d	<u>C</u> ustomer defined <u>i</u> dentify number - an indicator can be associated with a physical position	0 to 9999		0

2.5.2 Alarm List

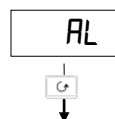

AL	Alarm list	Comments	Adjustable Range	Default
1---	Alarm <u>1</u> setpoint	The last three letters indicate the Alarm type. See section 2.2.4. If the alarm is disabled the parameter will not appear in this list	Between low and high setpoint limits which	0
2---	Alarm <u>2</u> setpoint		As set in the SP list.	0
3---	Alarm <u>3</u> setpoint		Rate of change alarms are direction sensitive	0
4---	Alarm <u>4</u> setpoint		from -9999 to +99999 units/sec or min	0

2.5.3 Setpoint List

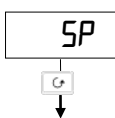

SP	Setpoint list	Adjustable Range	Default
SP L	Setpoint <u>l</u> ow limit - PV alarms	Input range min and max (combination of inputs 1 & 2)	As per Order code
SP H	Setpoint <u>h</u> igh limit - PV alarms		

2.5.4 Input List

, P



, P	Setpoint list	Adjustable Range	Default
intE	Input filter <u>integrating</u> time constant Set to a value which reduces the effect of any input noise to an acceptable level. The higher the value the more sluggish the response	OFF to 999.9 seconds	1.6

2.5.5 User Calibration Lists - Inputs 1 and 2

CAL. 1 or **CAL. 2** (**CAL. 2** only appears if input 2 has been configured)





CAL.-	User calibration 1 or 2 list	Adjustable Range	Default
TArE	Performs automatic ' <u>Tare</u> ' correction See also section 2.3.	OFF = Off on = start correction buSY = inputting value donE = finished inputting value	OFF

2.5.6 Access List

ACC5



The Access List provides password protected access to further levels of operation as listed below. See section 3 for further details.

codE	A code number can be entered using the  or  buttons. If an incorrect code number is entered the display will revert to <codE> . If no button is pressed within 45 seconds the indicator will automatically return to the HOME display.
-------------	---

For information on further levels of access, see the following sections.

3 Password Protected Levels of Operation











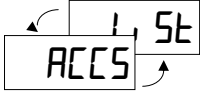

3.1 Access levels

Parameters are protected under different levels of access for which numerical password codes can be set up. The levels are:-

Access Level	What you can do	Default Code
<i>OPEr</i>	To view and adjust a limited set of parameters within limits set in higher levels	
<i>FuLL</i>	To view and adjust all parameters which are required to operate the indicator	1
<i>Edi t</i>	Allows parameters to be hidden or promoted to operator levels (see section 3.4)	1
<i>ConF</i>	Allows access to configure the fundamental characteristics of the indicator	2
<i>CALP</i>	This special level which appears in the CAL1 and CAL2 lists allows access to the calibration procedure for the indicator	3

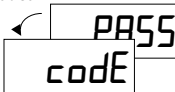
The following sections this manual describe the features available in Full, Edit and Configuration levels.

3.1.1 To Select Full or Edit Access Levels

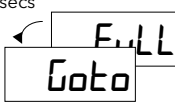
Do This	This Is The Display You Should See	Additional Notes
1. From any display press  as many times as necessary to access the 'Access List' header menu		If  or  are pressed the word <LiSt> is displayed for 2 seconds 
2. Press  to show <codE> Press  or  to enter the password	2 secs 	The factory default password is 1 <PASS> will be displayed momentarily when the correct password is been entered
3. Press  to show <Goto>		In the special case that the passcodes have been configured as 0, it will not be necessary to enter a passcode
4. Press  or  to select <FuLL> level	2 secs 	Options are: <OPEr> Operator level - shows selected operator parameters <FuLL> Reveals the 'FULL' set of parameters <Edi t> Allows parameters to be hidden or promoted <ConF> Gives access to configuration level (see section 4). The factory default password is 2



Having entered a higher level you can select <OPEr>, <FuLL> or <Edi t> levels at will.

Remember to return to <OPEr> level following completion of commissioning or configuring the instrument..



This may be done by:-

1. Switching the indicator off and back on again.

OR

2. Go to <OPEr> level and enter a false password number to re-lock the indicator in this level.

3.2 Navigation Diagram (full and edit levels)

Use the following lists to adjust:

- The alarm setpoints
- The alarm setpoint limits
- The input filter time constant
- The User calibration
- The communications address

The diagram below shows the complete list of possible parameters which may be shown in Full and Edit access levels. In practice, the parameters that appear will depend upon the configuration of your particular indicator .

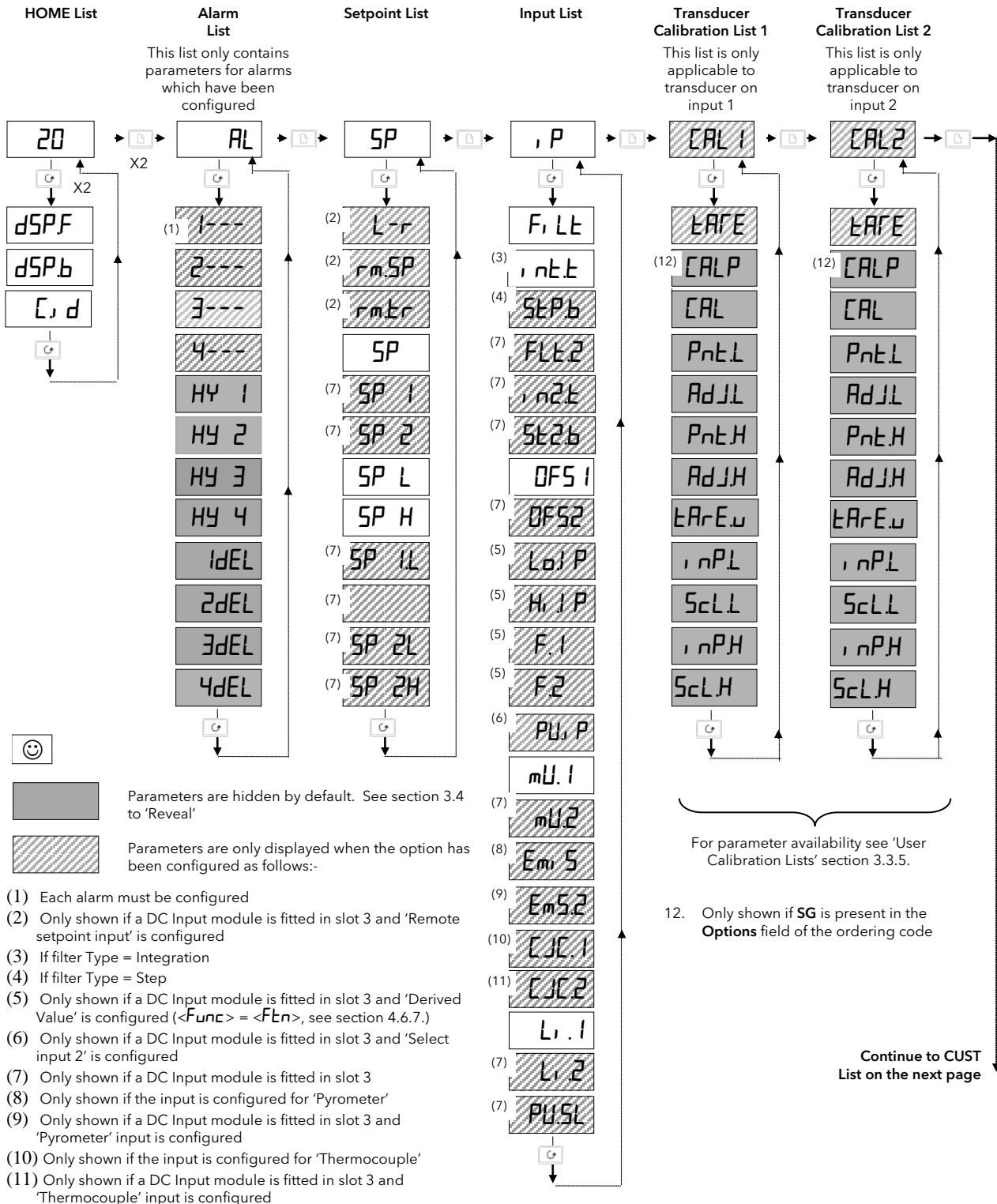



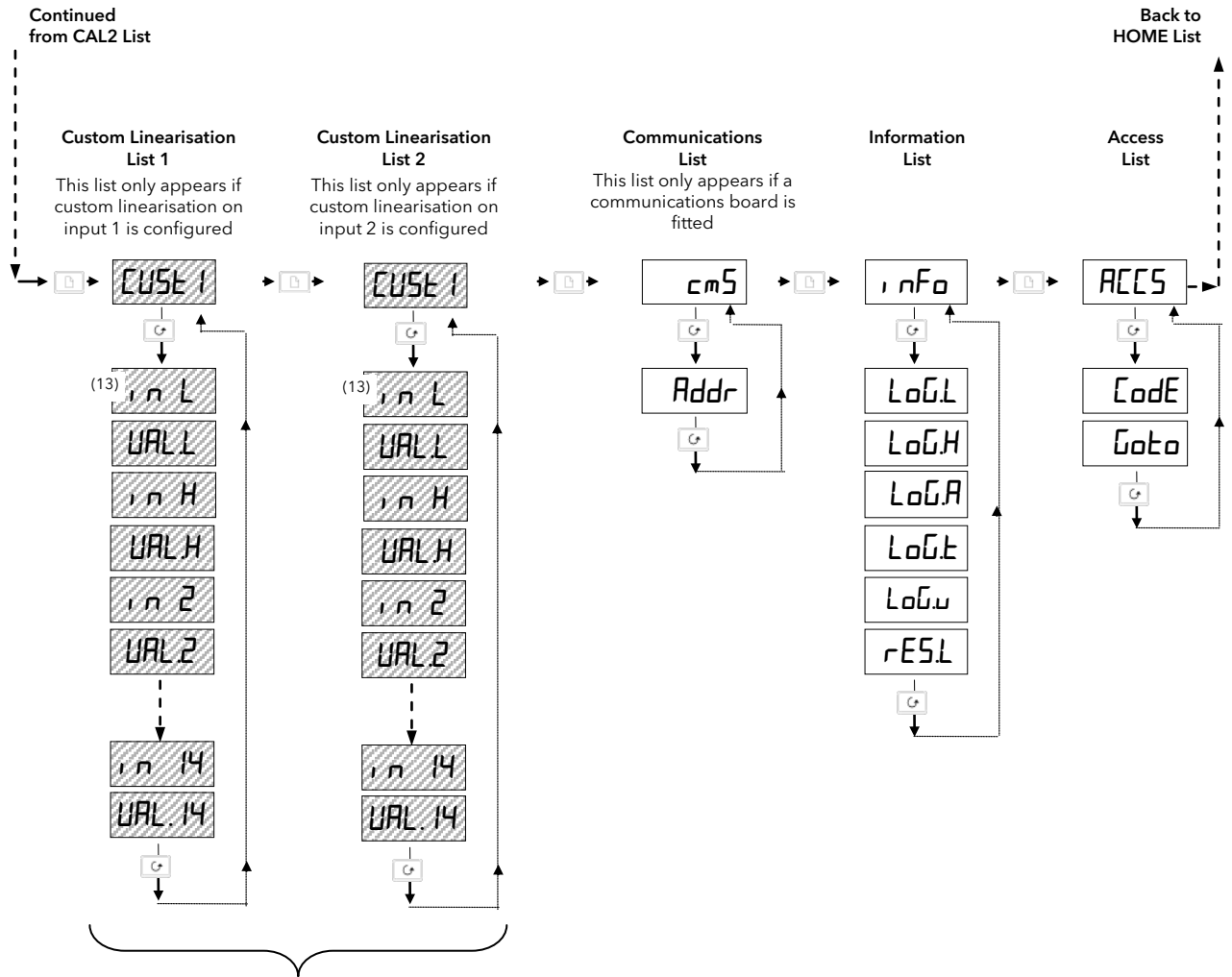

Figure 3-1: Navigation Diagram

Summary

- A. Press  to step across the list headings.
- B. Press  to step down the parameters within a particular list. You will eventually return to the list heading.
- C. Press  to view the value of a selected parameter. Keep pressing to decrease the value.
- D. Press  to view the value of a selected parameter. Keep pressing to increase the value.



13. Only shown if:- $\langle mUE \rangle$, $\langle UE \rangle$ or $\langle nAE \rangle$ are configured, see Sensor Input Configuration List section 4.5.2.

3.3 Parameter Tables

3.3.1 HOME List

20



Mnem-onic	Meaning	Adjustable Range	Default setting	Customer setting
dSPF	HOME display front	See 'HOME display options' section 2.1.2.	PU	
dSPb	HOME display back		None	
C, d	Customer defined identity number	0 to 9999	0	

3.3.2 Alarm List

AL



Mnem-onic	Meaning	Adjustable Range	Default setting	Customer setting
1---	Alarm 1 setpoint	Between low and high setpoint limits which are set in the <SP> list Rate of change alarms are direction sensitive from -9999 to +99999 units/sec or min	0	
2---	Alarm 2 setpoint		0	
3---	Alarm 3 setpoint		0	
4---	Alarm 4 setpoint		0	
In place of dashes, the last three letters indicate the alarm type: as shown in the 'Alarm Messages' table section 2.2.4.				
If the alarm is disabled the parameter will not appear in this list				
HY 1	Alarm 1 Hysteresis	Prevents relay 'chatter' by setting a difference between the relay ON and OFF points	1 to 99999 display units	1
HY 2	Alarm 2 Hysteresis		1 to 99999 display units	1
HY 3	Alarm 3 Hysteresis		1 to 99999 display units	1
HY 4	Alarm 4 Hysteresis		1 to 99999 display units	1
1dEL	Alarm 1 delay	Used to ignore transient alarms. Alarms must be true for the delay time before they become active	0 to 999.9 seconds	0
2dEL	Alarm 2 delay		0 to 999.9 seconds	0
3dEL	Alarm 3 delay		0 to 999.9 seconds	0
4dEL	Alarm 3 delay		0 to 999.9 seconds	0
1nAL	Inhibit alarm timer	To inhibit alarms for a time, see section 4.5.5	0n/OFF	OFF
1nHL	Time alarm inhibited		0 to 999.9 seconds	0

3.3.3 Setpoint List

SP



Mnem-onic	Meaning	Adjustable Range	Default setting	Customer setting
L- r	Remote setpoint enable	Loc Select local SP rmt Select remote SP	Loc	
rmSP	Remote master setpoint (for deviation alarms)	Displays remote SP value	N/A	Read only
rmtr	Remote setpoint track. This parameter only appears if remote setpoint has been configured	OFF No tracking trAc Local SP tracks remote SP	OFF	
SP 1	Local master setpoint value for deviation alarms on input 1	SP 1L to SP 1H	20	
SP 2	Local master setpoint value for deviation alarms on input 2	SP 2L to SP 2H	20	
SP	Setpoint value when the combination of inputs 1 & 2 provide the measured value to the indicator (for deviation alarms)	SP L to SP H		
SP L SP H	PV Alarms Setpoint low limit Setpoint High limit	Input range min and max (combination of input 1 2)	As per order code	
SP 1L SP 1H	Input 1 Alarms Setpoint Low Setpoint High	Between input 1 sensor range min and max	As per order code	
SP 2L SP 2H	Input 2 Alarms Setpoint Low Setpoint High	Between input 2 sensor range min and max	As per order code	

3.3.4 Input List

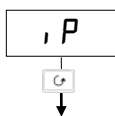

Mnemonic	Meaning		Adjustable Range		Default setting	Customer setting
<i>F₁Lt</i>	Input 1 <u>F</u> ilter Type	For explanation of filter action see section 3.3.4.2.	<i>OFF</i> <i>I n t</i> <i>S t E P</i>	No input filter Integrating Step		
<i>I n t t</i>	Input 1 <u>f</u> ilter time constant	Appears if Filter Type = <i><I n t></i> Used to reduce process value flicker on any input other than weigh scales	<i>OFF</i> to <i>999.9</i> seconds		<i>1.6</i>	
<i>S t P b</i>	Input 1 filter Step <u>B</u> and	Appears if Filter Type = <i><S t E P></i> Used to reduce process value flicker on weigh scale inputs	<i>1</i> to <i>100</i> (% maximum noise band)		<i>10</i>	
The above three parameters are repeated for input 2 as <i><F L t 2></i> , <i><I n t 2></i> and <i><S t 2 b></i> respectively						
<i>O F S 1</i>	Input 1 calibration <u>O</u> ffset	See section 3.5.1	<i>999.9</i> to <i>999.9</i>			
<i>O F S 2</i> ⁽¹⁾	Input 2 calibration <u>O</u> ffset		<i>999.9</i> to <i>999.9</i>			
<i>L o J P</i> <i>H i J P</i>	Transition of indication between input 1 and 2 (if configured) <ul style="list-style-type: none"> The displayed value is derived from input 1 when PV is below <i><L o J P></i> and from input 2 when PV is above <i><H i J P></i> When PV is between <i><L o J P></i> and <i><H i J P></i> the displayed value is a combination of both inputs <i><L o J P></i> cannot be set to a value above <i><H i J P></i> This is described further in section 4.6.9.1		Between input sensor range minimum and maximum.		As per order code	
<i>F . 1</i> ⁽²⁾	<i><F . 1></i> and <i><F . 2></i> are constants to achieve a derived PV where PV = <i><F . 1></i> x input 1 + <i><F . 2></i> x input 2		<i>-9.99</i> to <i>10.00</i>		<i>0.5</i>	
<i>F . 2</i> ⁽²⁾			<i>-9.99</i> to <i>10.00</i>		<i>0.5</i>	
<i>P U, P</i> ⁽¹⁾	Selects input 1 or input 2		<i>, P . 1</i> <i>, P . 2</i>	Input 1 selected Input 2 selected	<i>, P . 1</i>	
<i>m U . 1</i>	Input 1 <u>m</u> V measured at the rear terminals				Read-only	Read-only
<i>m U . 2</i> ⁽¹⁾	Input 2 <u>m</u> V measured at the rear terminals (module 3)				Read-only	Read-only
<i>C J C . 1</i>	Input 1 <u>C</u> old junction compensation temperature measured at the rear terminals. Only applies if the input 1 type = thermocouple				Read-only	Read-only
<i>C J C . 2</i> ⁽¹⁾	Input 2 <u>C</u> old junction compensation temperature measured at the rear terminals (module 3) Only applies if the input 2 type = thermocouple				Read-only	Read-only
<i>E m, S</i>	Input 1 <u>E</u> missivity. Only applies if the input 1 type = pyrometer					
<i>E m S 2</i> ⁽¹⁾	Input 2 <u>E</u> missivity. Only applies if the input 2 type = pyrometer					
<i>L i . 1</i>	Input 1 <u>L</u> inearised value				Read-only	Read-only
<i>L i . 2</i> ⁽¹⁾	Input 2 <u>L</u> inearised value (module 3)				Read-only	Read-only
<i>P U S L</i>	Shows the currently selected PV input	<i>, P . 1</i> <i>, P . 2</i> <i>both</i>	Input 1 selected Input 2 selected Both input 1 and input 2 are configured		<i>, P . 1</i>	

Notes:

- (1) These parameters only appear if input 2 has been configured
- (2) These parameters only appear if a derived input has been configured

3.3.4.1 Example: To Measure to Differential Between Input 1 and Input 2

- From the above list, select *<F . 1>* and set its value to 1.
- From the above list, select *<F . 2>* and set its value to -1.
- The derived PV will read the difference between Input 1 and Input 2

3.3.4.2 Filter Type

There are three settings for the filter type

- Filter Type = Off.** The display will respond immediately to any change in the PV input. If, however, there is any input noise this will result in fluctuations of the reading
- Filter Type = Integrating action.** This is designed for all process input types with the exception of weigh cell transducers as explained in section 3.6. The function is exponential which means that, for a step change in the input, the displayed value will move rapidly at first towards the new reading then gradually slow as the reading approaches the PV value. The effect is that small rapidly changing input values are ignored. The rate of response is set, in seconds, by the parameter *INTE*, which only appears for this type of filter. The larger the value the more sluggish the response
- Filter Type = Step Band.** This is specifically designed for weighing applications. The filter only responds when the displayed value becomes close to the measured value. This means that for a step change in the input the displayed value will change rapidly towards the measured value then slow as it reaches this value. The step band is set by the parameter *STEPB* which only appears for this type of filter. The units approximate to 1µV steps - the larger the setting more sluggish the response over the final stages of the reading. This type of filter is used, for example, where a weigh bridge or load cell is subject to vibrations

3.3.5 User Calibration Lists

These lists only appear if the 'Type of Calibration', *<TYPE>*, is configured for strain gauge type transducer applications (see Configuration Chapter for further details). The lists below are shown for each type of calibration. If *<TYPE>* = *<OFF>* the lists are not displayed.

Some parameter mnemonics remain the same for each type of transducer, but their functions may vary in detail between the different types. The tables are repeated, therefore, for each calibration type.

The tables are followed by a description of procedure to use for each type of calibration.

3.3.5.1 Calibration Type = Shunt (*<TYPE>* = *<Shnt>*)

See also section 3.6.1.

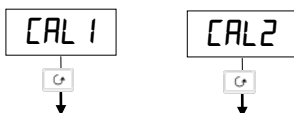

Mnem- onic	Meaning	Adjustable Range	Default setting	Customer setting
<i>TARe</i>	Performs automatic 'Tare' correction See 'USER CALIBRATION' section for further description	<i>OFF</i> = Off <i>on</i> = Start correction <i>buSy</i> = Calculating value	<i>OFF</i>	
<i>CALP</i>	Calibration password -See 'USER CALIBRATION'	0 to 99999	3	
The following three parameters only appear when the correct password has been entered				
<i>CAL</i>	Calibration type	<i>FACT</i> Factory calibration restored <i>USER</i> User calibration enabled	<i>FACT</i>	
The following two parameters are only shown if <i><USER></i> is selected as the calibration type				
<i>PnEL</i>	Start point low calibration Note: In shunt mode this parameter starts both zero and span calibration. Its mnemonic is common to other transducer applications	<i>OFF</i> Calibration complete <i>on</i> Start calibration	<i>OFF</i>	
<i>TAReu</i>	Tare Value This allows a fixed offset to be applied to the displayed reading. It must be set before auto tare is started	-999.9 to 99999 display units	0.0	
<i>SG</i>	Specific gravity multiplier For materials with specific gravity different from water (1)	0.01 to 999.9	1.00	
<i>ScLL</i>	Scale Low point Defines the low calibration point for the transducer (normally 0% of the transducer range)	-999.9 to 99999 display units	0	
<i>ScLH</i>	Scale High point Defines the high calibration point for the transducer (normally 80% of the transducer range)	-999.9 to 99999 display units	0	

3.3.5.2 Calibration Type = Load Cell (<TYPE> = <LDL>)

See also section 3.6.3.

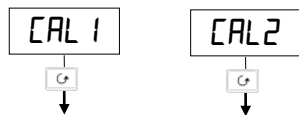

Mnemonic	Meaning	Adjustable Range	Default setting	Customer setting
EARe	Performs automatic 'Tare' correction See 'User Calibration' section for further description	OFF = Off on = Start correction buSY = Calculating value	OFF	
CALP	Calibration password -See 'USER CALIBRATION'	0 to 99999	3	
The following four parameters only appear when the correct password has been entered				
CAL	Calibration type	FACT Factory calibration restored USER User calibration enabled	FACT	
The following three parameters are only shown if <USER> is selected as the calibration type				
PnL	Start point low calibration	OFF Calibration complete on Start low point calibration	OFF	
PnH	Start point high calibration	OFF Calibration complete on Start high point calibration	OFF	
EAReu	Tare Value This allows a fixed offset to be applied to the displayed reading. It must be set before auto tare is started	-999.9 to 99999 display units	00	
SG	Specific gravity multiplier For materials with specific gravity different from water (1)	0.01 to 9999	1.00	
ScLL	Scale Low point Defines the value which will be displayed when the load is removed from the cell	-999.9 to 99999 display units	0	
ScLH	Scale High point Defines the value which will be displayed when the load is placed on the cell	-999.9 to 99999 display units	0	

3.3.5.3 Calibration Type = Comparison <TYPE> = <CMP>

See also section 3.6.5.

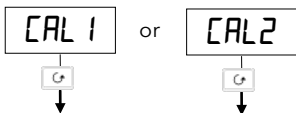

Mnemonic	Meaning	Adjustable Range	Default setting	Customer setting
TARE	Performs automatic 'Tare' correction. See 'USER CALIBRATION' section for further description	OFF = Off on = Start correction busy = Calculating value	OFF	
CALP	Calibration password. See 'USER CALIBRATION'	0 to 99999	3	
The following four parameters only appear when the correct password has been entered				
CAL	Calibration type	FACT Factory calibration restored USER User calibration enabled	FACT	
The following three parameters are only shown if <USER> is selected as the calibration type				
PnLL	Start point low calibration	OFF Calibration complete on Start low point calibration	OFF	
PnHH	Start point high calibration	OFF Calibration complete on Start high point calibration	OFF	
TAREu	Tare Value	This allows a fixed offset to be applied to the displayed reading. It must be set before auto tare is started	-999.9 to 9999.9 display units	0.0
SG	Specific gravity multiplier	For materials with specific gravity different from water (1)	0.01 to 999.9	1.00
ScLL	Scale Low point	Automatically adjusts to the value entered at <PnLL>	-999.9 to 9999.9 display units	
ScLH	Scale High point	Automatically adjusts to the value entered at <PnHH>	-999.9 to 9999.9 display units	

Calibration Type = Manual <TYPE> = <MAN>

See also section 3.6.7.

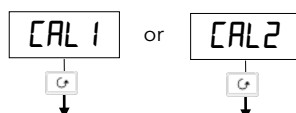

Mnemonic	Meaning	Adjustable Range	Default setting	Customer setting
CALP	Calibration password -See 'USER CALIBRATION'	0 to 99999	3	
The following four parameters only appear when the correct password has been entered				
CAL	Calibration type	FACT Factory calibration restored USER User calibration enabled	FACT	
The following three parameters are only shown if <USER> is selected as the calibration type				
inPL	Input low	Set to the low electrical input which is to correspond to the low display reading	-999.9 to 9999.9 display units	
ScLL	Scale Low point	Set to the display reading corresponding to <inPL>	-999.9 to 9999.9 display units	0
inPH	Input high	Set to the high electrical input which is to correspond to the high display reading	-999.9 to 9999.9 display units	
ScLH	Scale High point	Set to the display reading which corresponds to <inPH>	-999.9 to 9999.9 display units	0

3.3.6 Custom Linearisation List 1 or 2

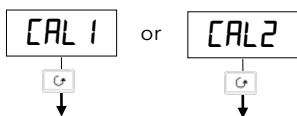

Mnemonic	Meaning	Adjustable Range	Default setting	Customer setting
<u>i</u> n <u>L</u>	Adjust <u>l</u> ow <u>i</u> nput value		min input	
<u>U</u> <u>A</u> <u>R</u> <u>L</u>	Adjust displayed <u>v</u> alue corresponding to input <u>l</u> ow		min display	
<u>i</u> n <u>H</u>	Adjust <u>h</u> igh <u>i</u> nput value		Max input	
<u>U</u> <u>A</u> <u>R</u> <u>H</u>	Adjust displayed <u>v</u> alue corresponding to input <u>h</u> igh		max display	
<u>i</u> n <u>2</u>	Adjust <u>i</u> nput break point <u>2</u> value			
<u>U</u> <u>A</u> <u>R</u> <u>2</u>	Adjust displayed <u>v</u> alue corresponding to point <u>2</u>			
to		The <u>v</u> alues entered must be continuously increasing or decreasing		
<u>i</u> n <u>14</u>	Adjust <u>i</u> nput break point <u>14</u> value			
<u>U</u> <u>A</u> <u>R</u> <u>14</u>	Adjust displayed <u>v</u> alue corresponding to point <u>14</u>			

This list only appears if a custom download input has been configured.

Further information on Custom Linearisation is given in section 3.7.



Having entered the values for the custom linearisation it is necessary to power down the instrument and power back up again to enter the values otherwise they will be clamped to zero. Alternatively enter then leave configuration level.

3.3.7 Digital Communications List

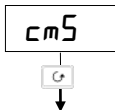

Mnem- onic	Meaning	Adjustable Range	Default setting	Customer setting
<i>Addr</i>	Indicator communications address	1 to 99 El Bisynch 1 to 254 Modbus	1	

This list only appears if digital communications has been configured.

3.3.8 Information List

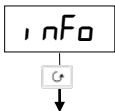

Mnem- onic	Meaning	Adjustable Range	Default setting	Customer setting
<i>LoGL</i>	Logged Minimum Process Value	Can be manually adjusted	Read-only	Read-only
<i>LoGH</i>	Logged Maximum Process Value			
<i>LoGA</i>	Logged Average Process Value			
<i>LoGt</i>	Time process value is above threshold level			
<i>LoGu</i>	Process value threshold for timer log			
<i>rESL</i>	Logging reset			
	These values are logged by the indicator from switch on To reset switch the indicator supply off and on again or scroll to <rESL> and select <YES>	Time displayed in minutes	Read-only	Read-only
		Between display min and max	0	
		<i>no</i> Logging in progress <i>YES</i> Will reset logged values	<i>no</i>	

3.3.9 Access List

The Access List is the same as section 2.5.6.

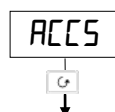

Mnem- onic	Meaning
<i>OPeR</i>	To view and adjust a limited set of parameters within limits set in higher levels
<i>FuLL</i>	To view and adjust all parameters which are required to operate the indicator
<i>Edi t</i>	Allows parameters to be hidden or promoted to operator levels (see section 3.4.)
<i>ConF</i>	Allows access to configure the fundamental characteristics of the indicator
<i>CALP</i>	This special level which appears in the CAL1 and CAL2 lists allows access to the calibration procedure for the indicator

3.4 To Hide, Reveal and Promote Parameters

In Edit level you can choose to customise the operator level display by choosing which parameters can be made available. The choices are:-

- <ALtR> The parameter will be alterable
- <Hi dE> The parameter will be hidden
- <rEAd> The parameter will be read-only
- <Pro> The parameter will be 'promoted' into the HOME list (see below)

3.4.1 List Headers

Any list of parameters shown in the Navigation Diagram, section 3.2. can be made available or hidden in Operator level.

Do This	This Is The Display You Should See	Additional Notes
1. Enter <Edi t> level as described in 3.1.1.		
2. Press to select the list to be hidden eg <SP> the setpoint parameters		If <Hi dE> is selected the complete list will not be available in Operator level
3. Press or to select <Hi dE> or <rEAd>		

3.4.2 Parameters

Any parameter in a list can be made available or hidden in the same way as the complete list header as described above. They can also be made read only or promoted as shown in the two following examples.

3.4.2.1 The <Pro> (Promote) Option

Up to twelve commonly used parameters can be 'promoted' into the HOME list. This will give the operator quick access to them by simply pressing the button. This feature, used in combination with 'hide' and 'read only' allows you to organise the way in which you want your indicator formatted.

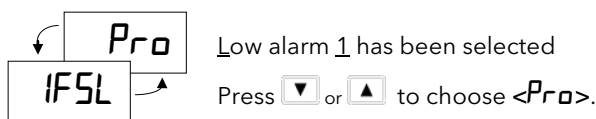

The parameter <IFSL> will now appear in the HOME list. Repeat the procedure for any other parameters you wish to promote.

To de-promote a parameter go to <Edi t> level, select the parameter from the relevant list and change the choice from <Pro> back to <ALtR>, <rEAd> or <Hi dE>.

3.4.2.2 Read Only Example

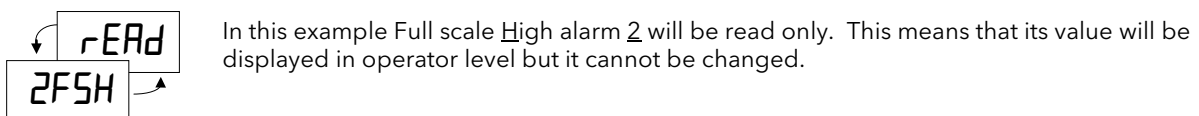

3.5 Calibration

The indicator is calibrated in three ways. These are:-

1. **Factory Calibration.** The controller is calibrated to very high accuracy during manufacture and the calibration values are permanently stored within the controller. Factory calibration is not available to the user
2. **Transducer Scaling.** Transducer scaling allows offsets to be entered to compensate for errors or differences in the process measurement system
3. **User Calibration.** This allows the instrument to be calibrated against known conditions in the actual process without affecting the factory calibration.

See also section 3.3.5. for the full list of calibration parameters

3.5.1 User Calibration

User calibration allows you to:-

1. Calibrate the controller to the your reference standards
2. Match the calibration of the controller to that of a particular transducer or sensor input
3. Calibrate the controller to suit the characteristics of a particular installation

The following can be calibrated:

1. **Input 1.** This applies to the fixed PV input on terminals V1, V+, V-. It allows you to set the displayed reading to correspond to the electrical input range on linear mV volt or mA inputs
2. **Input 2.** This applies to module 3 when fitted with a DC Input module. It allows you to set the displayed reading to correspond to the electrical input range on linear mV volt or mA inputs
3. **Analogue I/O Modules** configured as DC Retransmission. It allows you set up the electrical output to correspond with the displayed value

3.5.1.1 Single Point Offset

A single offset applies to Inputs 1 & 2 and applies a fixed offset over the full display range of the controller.

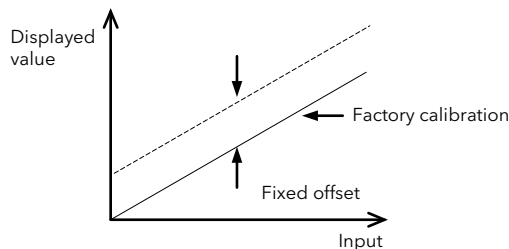

To calibrate, proceed as follows:

1. Connect the input of the controller to the source device to which you wish to calibrate.
2. Set the source to the desired calibration value.
3. The controller will display the current measurement of the value.
4. If the displayed value is correct, then the controller is correctly calibrated and no further action is necessary. If it is incorrect, then follow the steps shown below.

Figure 3-2: Fixed Offset

3.5.1.2 To Apply an Offset to Input 1

Do This	This Is The Display You Should See	Additional Notes
1. From any display press as many times as necessary to access the <P List> header menu		
2. Press to show <OFS. 1> (Offset on input 1)		An offset on Input 1 of +1.0 unit will be applied over the full range of the input. The same procedure is followed to apply an offset to Input 2
3. Press or to enter the required offset		

3.5.1.3 Two Point Calibration

Two point calibration is only available in Configuration level and allows you to adjust both the low point (zero) and high point (span) independently. The procedure is shown in the example in section 3.6.7.

3.6 Transducer Calibration

This indicator supports a number of different two and four wire transducer types. Each type is explained in this section.

3.6.1 Shunt Calibration

Shunt calibration is so called since it refers to switching a calibration resistor across one arm of the four wire measurement bridge in a strain gauge transducer. It also requires the use of a Transducer Power Supply module wired as shown in Figure 3-3.

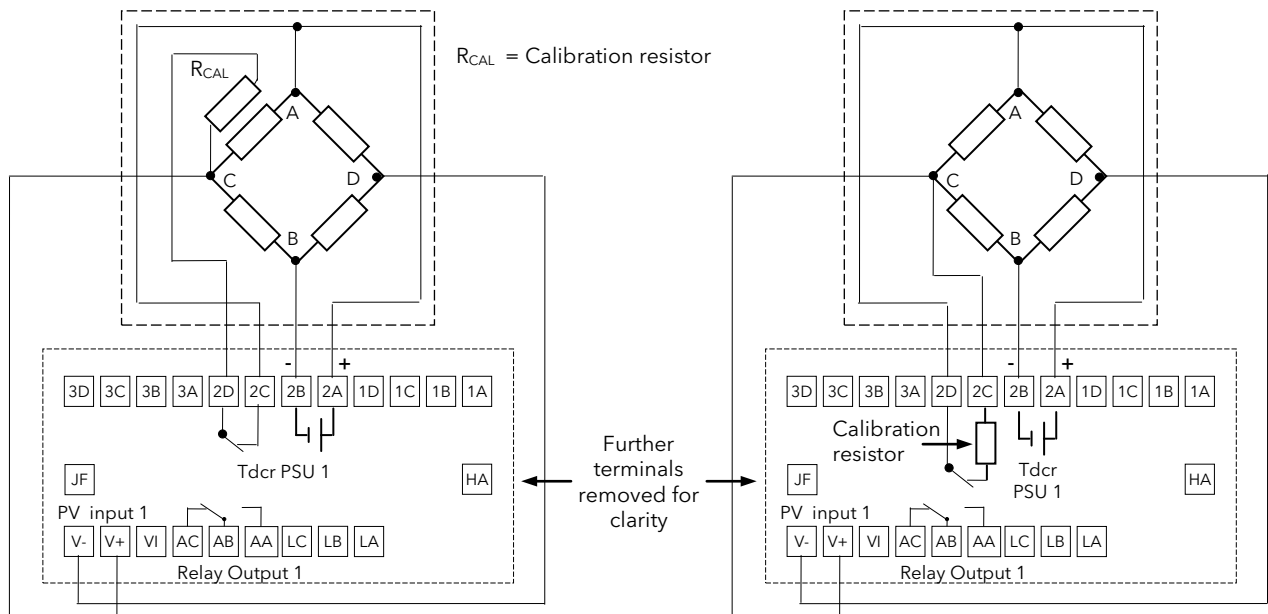

Wiring for Transducer with Internal Calibration Resistor

Wiring for Transducer with External Calibration Resistor

Both diagrams show connections to Input 1/main input.
If Input 2 is used in module position 3, the transducer output can be connected to terminals 3C (+) and 3D (-)

Figure 3-3: Wiring for Strain Gauge Calibration

3.6.2 To Calibrate a Strain Gauge Bridge Transducer

The strain gauge transducer is calibrated as follows:-











1. Remove any load from the transducer to establish a zero reference
2. Enter 'Scale Low' $\langle S_{CLL} \rangle$ and 'Scale High' $\langle S_{CLH} \rangle$ values which are normally set at 0% and 80% of the span of the transducer
3. Start the procedure using the low point calibration parameter $\langle P_{nTL} \rangle$, or a digital input wired to this parameter

The indicator will automatically perform the following sequence for a transducer with its own integrated calibration resistor:







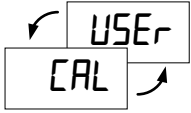



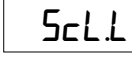

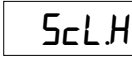

1. Disconnect the shunt resistor
2. Calculate the low point calibration value by continuously averaging two lots of 50 measurements of the input until stable readings are obtained
3. Connect the shunt resistor by closing a contact between terminals D and C.
4. Calculate the high point calibration value by averaging two lots of 50 measurements of the input

For transducers which do not contain a calibration resistor the indicator will switch in its own internal calibration resistor.

First - Enter The Calibration Password

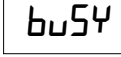
Do This	This Is The Display You Should See	Additional Notes
1. From any display press  as many times as necessary to access the <CAL I> (or <2>) List' header		
2. Press  to scroll to <CALP>		
3. Press  or  to enter the calibration password. In a new instrument the default is <3>		 The first parameter in the list is <LArE> Calibration of Tare weight has already been described in Operator Level Section 2.3
4. Press  to show <CAL>		When the correct password is entered <PASS> will flash briefly on the display A password of <0> allows the instrument to proceed directly to the next parameter
5. Press  or  to turn calibration to <USEr>		See start of this section for a description of User and Factory calibration

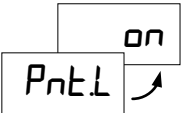
Next - Calibrate the Strain Gauge Transducer

Do This	This Is The Display You Should See	Additional Notes
6. Press  to scroll to <ScLL>		 This sets the minimum (zero) point at which the transducer is to be calibrated. This is typically 0%.
7. Press  or  to enter the scale low value (normally 0)		
8. Press  to scroll to <ScLH>		This sets the maximum (span) point at which the transducer is to be calibrated. This is typically 80% of the transducer range.
9. Press  or  to enter the scale high value		
10. Press  to show <PntL>		 The indicator will show 'busy' while calibrating before returning to <PntL>
11. Press  or  to turn calibration to <on>		If the calibration fails the alarm message <tdrF> is flashed The <PntL> parameter may have been wired to a digital input for activation by an external switch
		 The operation is identical except that the indication will return to the display which was being shown prior to the activation of the switch

3.6.3 Load Cell Calibration

A load cell with V, mV or mA output may be connected to Input 1 or Input 2.

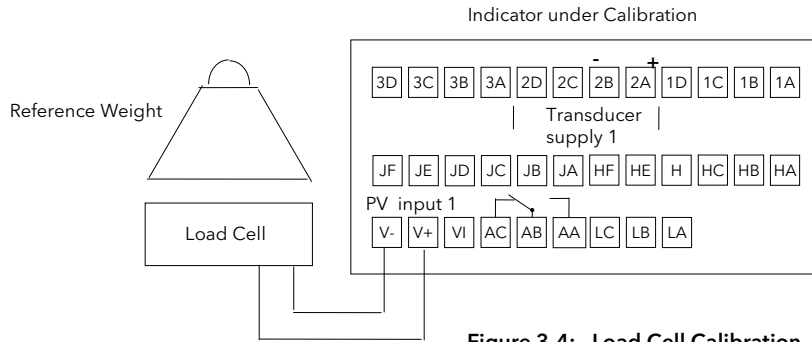

This diagram shows connections to input 1/main input

If Input 2 is used in module position 3, the transducer output can be connected to terminals 3C (+) and 3D (-)

Figure 3-4: Load Cell Calibration

3.6.4 To Calibrate a Load Cell

The load cell is calibrated as follows:

1. Set $\langle S_{cL.L} \rangle$ and $\langle S_{cL.H} \rangle$ for the required 'zero' and 'span' readings on the display
2. Remove any load and start the procedure using the low point calibration parameter $\langle P_{nt.L} \rangle$
3. or a digital input wired to this parameter. The indicator will calculate the low calibration point
4. Place a reference weight on the load cell and turn on the high point calibration parameter $\langle P_{nt.H} \rangle$, or a digital input wired to this parameter. The indicator will then calculate the high calibration point.

Note:-

If $\langle P_{nt.L} \rangle = 'On'$, $\langle P_{nt.H} \rangle$ cannot be turned to $\langle on \rangle$

If $\langle P_{nt.H} \rangle = 'On'$, $\langle P_{nt.L} \rangle$ cannot be turned to $\langle on \rangle$

Either must complete before the other can be set to $\langle on \rangle$

First enter the calibration password as described in section 3.6.2.

Then:-

Do This	This Is The Display You Should See	Additional Notes
Set the required display 'Span' and 'Zero' parameters		
6. Press to scroll to $\langle S_{cL.L} \rangle$		This sets the minimum (zero) display reading when the transducer has its lowest weight
7. Press or to enter the scale low value (normally 0)		This sets the maximum (span) display reading when the transducer has its highest weight
8. Repeat for $\langle S_{cL.H} \rangle$		
Set the load cell to its 'zeroed' condition		
9. Press to show $\langle P_{nt.L} \rangle$		The indicator will show 'busy' while calibrating
10. Press or to turn calibration to $\langle on \rangle$		If the calibration fails the alarm message $\langle tdrF \rangle$ is flashed
When the calibration low point is complete, place the reference load on the load cell		
11. Press to show $\langle P_{nt.H} \rangle$		The indicator will show 'busy' while calibrating and will flash $\langle donE \rangle$ when complete
12. Press or to turn calibration to $\langle on \rangle$		If the calibration fails the alarm message $\langle tdrF \rangle$ is flashed
		The $\langle P_{nt.L} \rangle$ and $\langle P_{nt.H} \rangle$ parameters may have been wired to digital inputs for activation by external switches The operation is identical except that the indication will return to the display which was being shown prior to the activation of the switches

3.6.5 Comparison Calibration

Comparison calibration is most appropriate when calibrating the indicator against a second reference instrument.

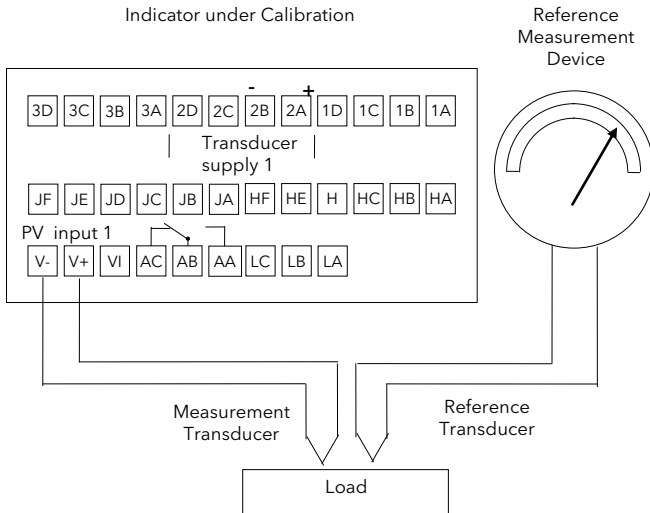

This diagram shows connections to Input 1/main input
If Input 2 is used in module position 3, the transducer output can be connected to terminals 3C (+) and 3D (-)

Figure 3-5: Comparison Calibration

3.6.6 To Calibrate by Comparison with an External Reference

In this case the process calibration points are not entered ahead of performing the calibration. The input may be set to any value and, when the system is stable, a reading is taken from the reference measurement device and entered into the indicator. The indicator stores both this new target value and the actual reading taken from its input.

The process is repeated at a different value, with the indicator storing both the new target value and the reading taken from its input.

First enter the calibration password as described in section 3.6.2.

Then:-

Do This	This Is The Display You Should See	Additional Notes
Allow the process to settle at the low calibration point		
6. Press to show <Pnt.L>		The indicator will alternate between the message 'Adjust' and the value shown in the main display If no key is pressed for 45 seconds the indicator will return to the HOME display This parameter can be configured to operate from a digital input which, in turn, may be connected to a push-button switch
7. Press or to turn calibration to <on>		
8. Press or to enter the value read by the reference instrument		The indicator will resume the alternating display The values will only be accepted by scrolling away from <Adj>, unless this parameter has been activated by a digital input
Allow the process to settle at the high calibration point		
9. Repeat 2 to 4 above for <Pnt.H>		This parameter can be configured to operate from a digital input which, in turn, may be connected to a push-button switch Note:- The low calibration point cannot be higher than the high calibration point These inputs can, however, be scaled to values which are inverted

The indicator is now calibrated against the reference source. When complete the indication returns to the HOME display.

3.6.7 Manual Calibration

In some installations a single offset (section 3.5.1) over the whole range may not be satisfactory. What is required is a method of applying independent offsets to both the lower end and higher end of the input range. An example might be to compensate for known errors in a sensor or sensor input connections but without changing the factory set calibration.

This feature is available in Configuration level in the 2408i indicator by configuring the 'type of calibration' (*TYPE*) in the Input List (iP) to Manual *mAn* (section 4.5.2). This two point offset applies a straight line fit between the low offset point and the high offset point as shown in the graph below. Any readings above or below the two calibration points will be an extension of this line. For this reason it is best to calibrate with the two points as far apart as possible.

Example:

Indicator input configured for mV.

A minimum input of 0.0mV to read 0. A maximum input of 10.0mV to read 1000.

In configuration level $i n P L = 0.0$, $i n P H = 10.0$, $S C L L = 0$, $S C L H = 1000$

Due to known errors in the transducer or it's connections an output from the transducer of 0.05mV should read 0 on the indicator and an output from the transducer of 10.2mV should read 1000 on the indicator. User offsets can be set up as follows:-

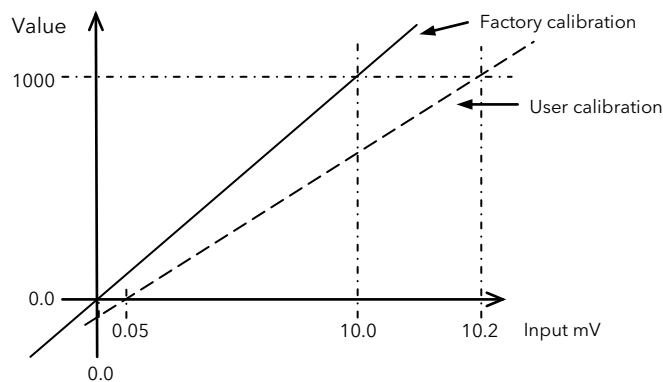

Figure 3-6: High and Low Offsets

In *FULL* access level enter the calibration password as described in section 3.6.2.

Then:-

Do This	This Is The Display You Should See	Additional Notes
6. Press to show < <i>i n P L</i> >		<p>Note: These parameters are scaling factors which default to $i n P L = 0$, $S C L L = 0$, $i n P H = 10000$, $S C L H = 10000$.</p> <p>If $i n P L$ and $S C L L$ have the same value and $i n P H$ and $S C L H$ have the same value, then no offsets are produced.</p> <p>This example sets $i n P L$ and $i n P H$ to 0 and 1000 to correspond with the readings required but it is possible to use the default values of 0 and 10000. In this case set $S C L H$ to 9800. This allows offsets to be set to a greater accuracy particularly where decimal points are displayed.</p>
7. Press or to adjust the input to the minimum electrical input, e.g. < -0.5 >		
8. Press to show < <i>S c L L</i> >		
9. Press or to adjust the input to the minimum display reading, e.g. < -5 >		
10. Press to show < <i>i n P H</i> >		
11. Press or to adjust the input to the minimum electrical input, e.g. < 120 >		
12. Press to show < <i>S c L H</i> >		
13. Press or to adjust the input to the minimum display reading, e.g. < 1000 >		

The above example shows an indicator configured for mV but the same procedure can be used for other input sensors including thermocouple and PRT sensors.

3.6.8 Auto-Tare or Display Zero

The auto-tare (display zero) function is used, for example, when it is required to weigh the contents of a container but not the container itself.

The procedure is to place the empty container on the weigh bridge and 'zero' the controller. Since it is likely that following containers may have different tare weights the auto-tare feature is always available in the indicator at Operator access level.

The effect of auto-tare is to introduce a DC bias to the measurement, as shown in Figure 3-6 below.

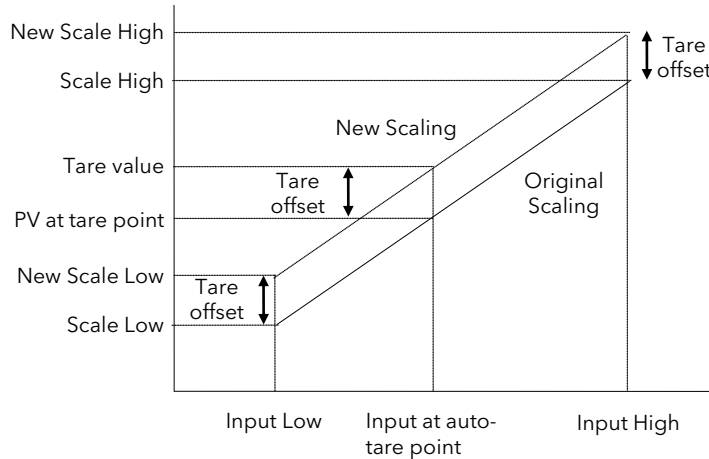

Figure 3-7: Effect of Auto-Tare

The procedure to initiate tare calibration was described in 2.3.

Note:- A Tare calibration will change the values of 'Scale High' <SCLL> and 'Scale Low' <SCLH>

The parameter <TAREW> sets a fixed offset on the tare value. This may be used, for example, if containers of different weights are placed on a pallet of known weight. This known weight can then be entered in <TAREW>.

3.6.9 To Enter a Fixed Offset to the Tare Value

Do This	The Display You Should See	Additional Notes
1. Press as many times as necessary to select 'CAL 1' or 'CAL2' as appropriate		
2. Press to scroll to 'CAL'		
3. Press or to select 'USER'		
4. Press to scroll to 'TAREW'		
5. Press or to enter the offset value		The offset value represents the weight of the pallet for example

If this value is to be changed on a regular basis, it may be convenient to 'promote' the TAREW parameter to the Operator level. The procedure for this is described in section 3.4.

3.7 Custom Linearisation

The linearisation uses a 15 point straight line fit.

Figure 3-7 shows an example of a curve to be linearised and is used to illustrate the terminology used in the parameter list

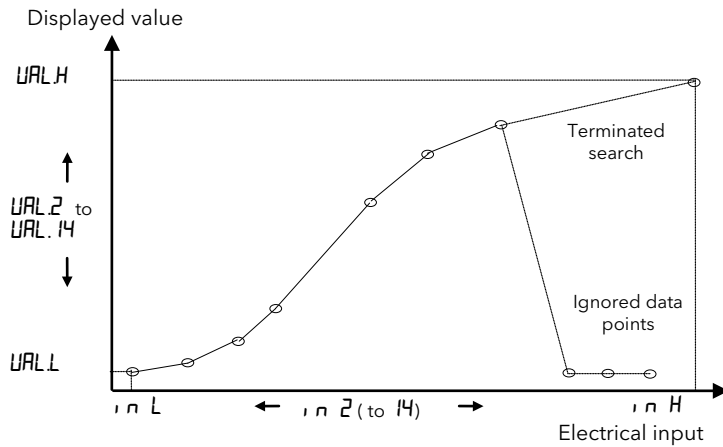

Notes:

1. The linearisation block works on rising inputs/rising outputs or rising inputs/falling outputs. It is not suitable for outputs which rise and fall on the same curve.
2. Input Lo/Output Lo and Input Hi/Output Hi are entered first to define the low and high points of the curve. It is not necessary to define all 15 intermediate points if the accuracy is not required. Points not defined will be ignored and a straight line fit will apply between the last point defined and the Input Hi/Output Hi point.

Figure 3-7: Linearisation Example

3.7.1 Example: To Linearise Input 1

Do This	This Is The Display You Should See	Additional Notes
1. Press as many times as necessary to access the <CUSE 1> list header menu		
2. Press to show <in L>		Input 1 is set to +1.0 units
3. Press or to enter the low electrical input value		
4. Press to show <UAL.L>		The display will read 2.0 corresponding to the low electrical input (+1 unit)
5. Press or to enter the low electrical input value		
6. Repeat steps 2 to 5 for the high end and then for all intermediate steps		Note:- The values entered must be continuously increasing or decreasing

3.7.2 Compensation for Sensor Non-Linearity's

The custom linearisation feature can also be used to compensate for errors in the sensor or measurement system, so that discontinuities in the curve can be calibrated out. Figure 3.8 shows an example of the type of discontinuity which can occur in the linearisation of a temperature sensor.

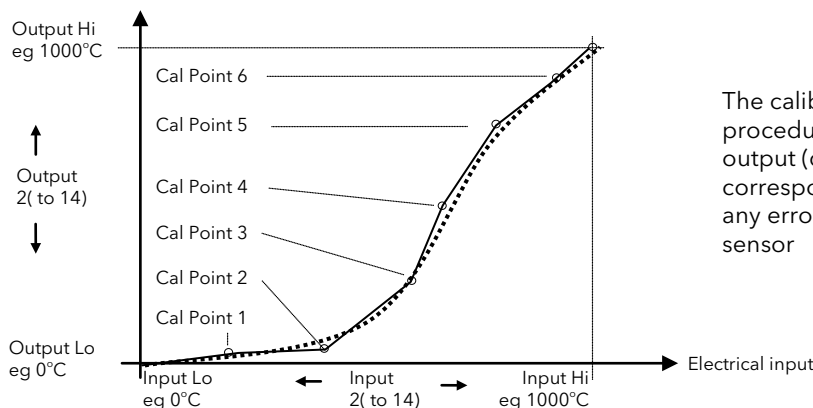

The calibration of the sensor uses the same procedure as described above. Adjust the output (displayed) value against the corresponding input value to compensate for any errors in the standard linearisation of the sensor

Figure 3-8: Sensor Non-linearity's







4 CONFIGURATION LEVEL

The 2408i indicator is supplied configured in accordance with the ordering code (see section 5). The configuration of the indicator, as defined by columns 11 to 16 of the order code, can be changed on site, if necessary, to meet the requirements of the installation. Similarly, the positions or types of plug in module can be changed if required. This section describes the procedures to be followed.

4.1 Hardware configuration - I/O Modules

Optional plug-in modules are fitted simply by sliding them into the relevant position as shown in Figure 4-1. The connections for these modules are made to the upper row of connector blocks as shown in section 1.3.

When a module is added, removed or changed the indicator will flash hardware error '<HWEr>' on power up. To acknowledge this it is necessary to go into configuration level.

1. Press either  or  until <ConF> is displayed.
2. Press  or  to enter the configuration level password passcode (factory default 2)
3. Press either  or  again and the hardware error is acknowledged

The full list of modules available is shown in the ordering code.



Figure 4-1: View of the Plug-in Modules















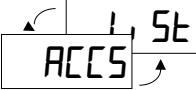

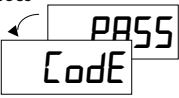
4.2 Software configuration

Configuration level allows you to set up parameters in the indicator which defines how it will operate. Examples are:-

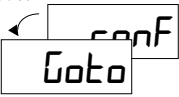
- The configuration of the alarms
- The digital input functions
- The relay output configuration
- The configuration of the modules
- The passwords

Parameter tables in this section give the full list of configuration parameters.

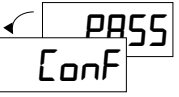
4.2.1 To Select Configuration Access Level

Do This	This Is The Display You Should See	Additional Notes
1. From any display press  as many times as necessary to access the 'Access List' header		If  or  are pressed the word <L St> is displayed for 2 secs 
2. Press  to show <Code>	2 secs 	The factory default passcode is <1> <PASS> will be displayed momentarily when the correct password has been entered
3. Press  or  to enter the passcode		In the special case that the passcodes have been configured as <0>, it will not be necessary to enter a passcode
4. Press  to show <Goto>	2 secs 	
5. Press  or  to select <conf> level		
6. Press  to show <Conf>	2 secs 	The configuration factory default passcode is <2> '<PASS>' will be displayed momentarily when the correct password has been entered
7. Press  or  to enter the configuration level passcode		In the special case that the passcodes have been configured as <0>, it will not be necessary to enter a passcode

The indicator is now in configuration level

4.3 Location of Parameters - From Indicator Block Diagram

The indicator consists of a number of internal function blocks connected together. Each function block has a number of parameters found in lists to which the user has access. The block diagram shows location of these parameters within the indicator.

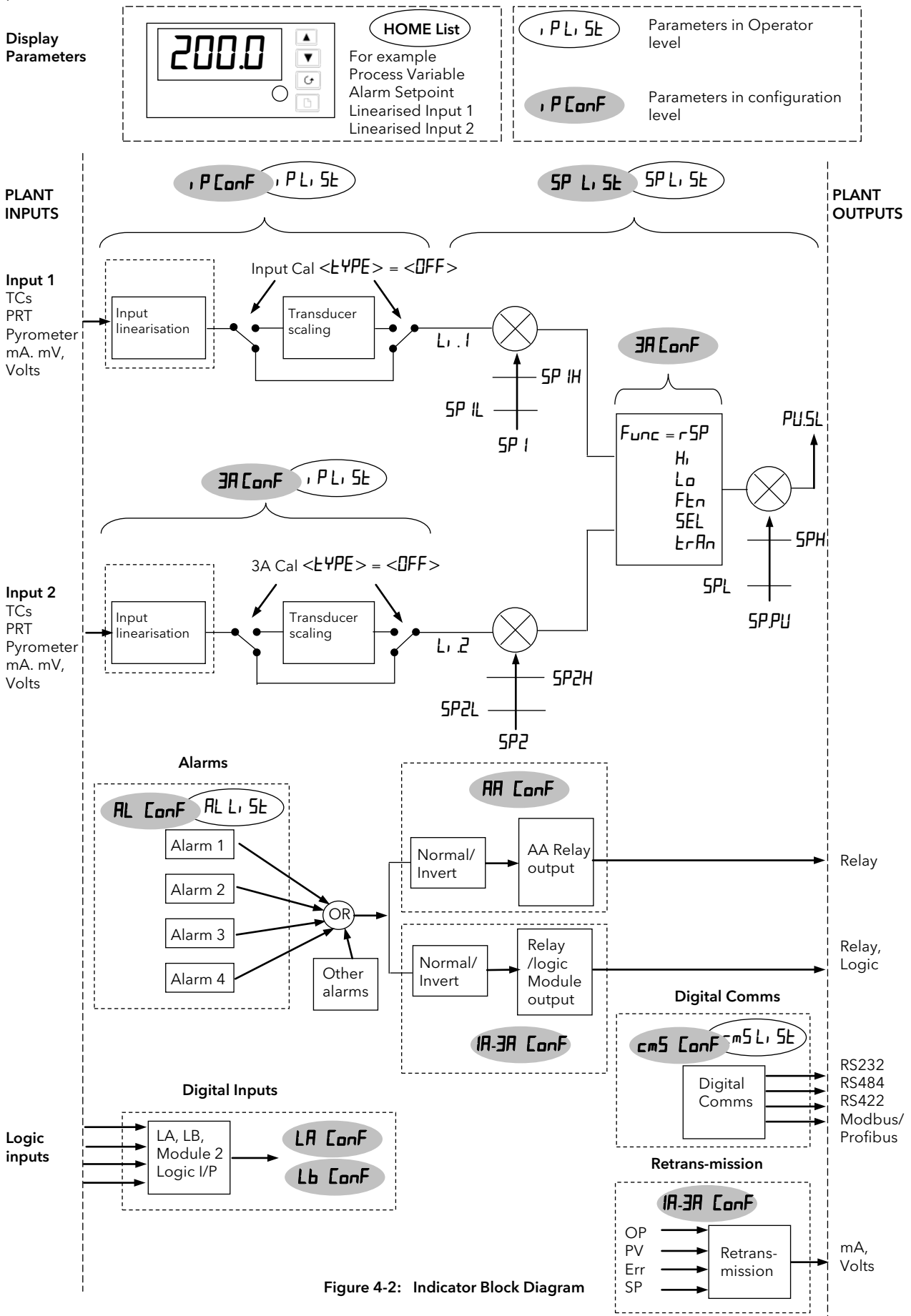

Figure 4-2: Indicator Block Diagram

4.4 Navigation diagram (configuration level)

The navigation diagram shows the location of configuration parameters.

- A. Press to step across the list headings. This is a continuous list.
- B. Press to step down the parameters within a particular list. You will eventually return to the list heading.
- C. Press to view the value of a selected parameter. Keep pressing to decrease the value.
- D. Press to view the value of a selected parameter. Keep pressing to increase the value.

The diagram below shows the full list of possible parameters. In practice, the parameters that appear will depend upon the configuration of your particular indicator .

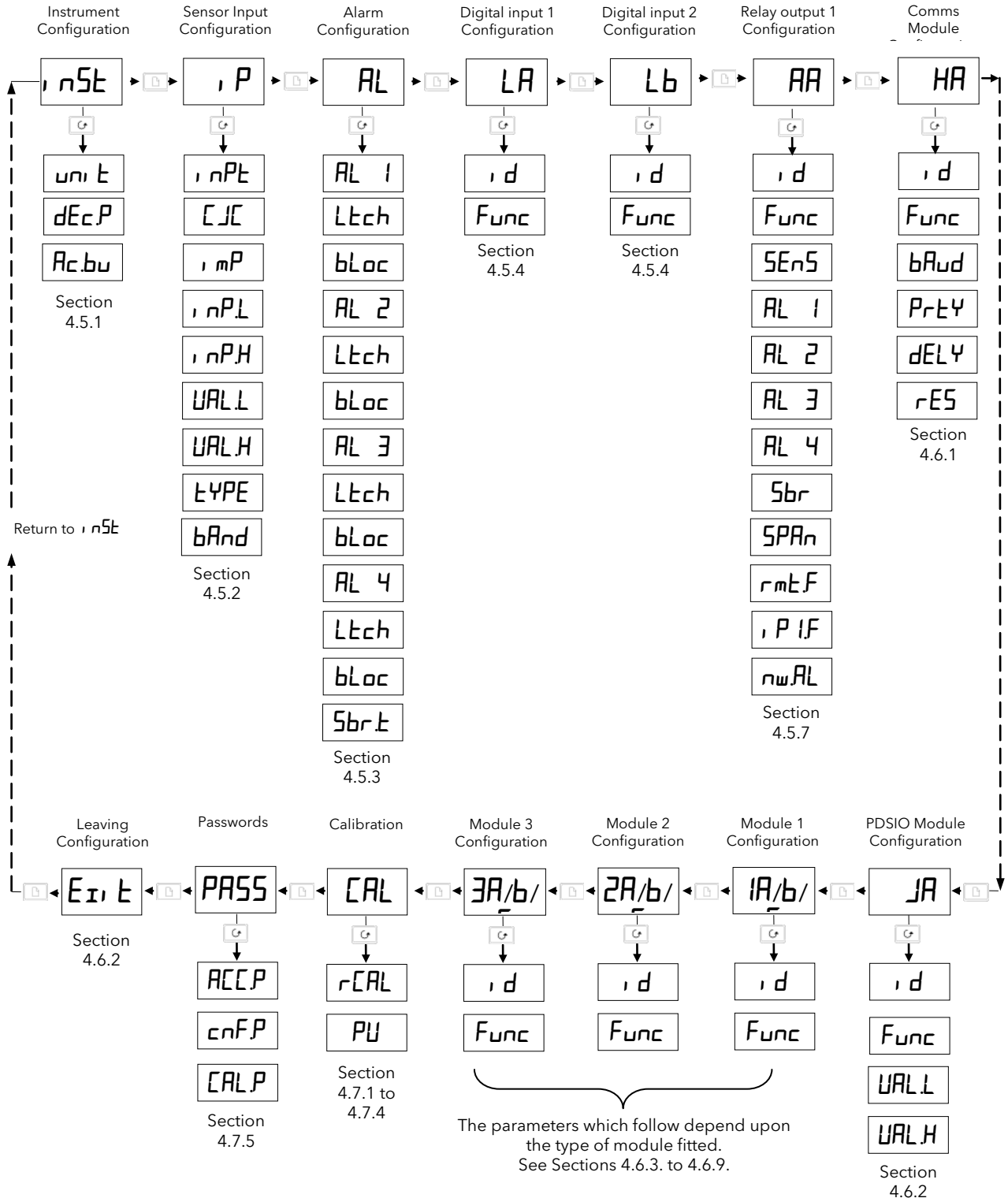
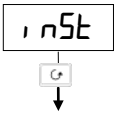

Figure 4-3: Navigation Diagram

4.5 Configuration Parameter Tables - All indicators

The tables in this section list the parameters available for the fixed functionality of the indicator.

4.5.1 Instrument configuration list



Inst	Instrument list	Option	Meaning	Default setting	Customer setting
units	To select display units	°C °F °K None	Celsius Fahrenheit Kelvin None (for linear inputs)	Defined by the ordering code, otherwise °C	
dECP	To set the number of decimal places in the display	None One Two Three	None One Two Three	Defined by the ordering code, otherwise None	
Ac.bu	To enable Front panel Ack/Reset button	EnAb di SA	Button enabled Button disabled	EnAb	

4.5.1.1 Example: To Change the Number of Decimal Places in the Display

Do This	This Is The Display You Should See	Additional Notes
Enter configuration level as described in section 4.2.1.		
1. Press until the 'Instrument List' header is shown		
2. Press until <dECP> is shown	2 secs 	The display will return to <dECP> after approximately 2 seconds
3. Press or to move the decimal point position		

4.5.1.2 Example: To Disable the Front Panel Ack/Reset Button





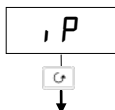

Do This	This Is The Display You Should See	Additional Notes
Enter configuration level as described in section 4.2.1.		
1. Press until the 'Instrument List' header is shown		
2. Press until <Ac.bu> is shown	2 secs 	The display will return to <Ac.bu> after approximately 2 seconds
3. Press or to select disabled		

4.5.2 Sensor Input Configuration List

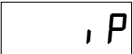

I, P	Sensor Input	Option	Meaning	Default setting	Customer setting
I nPt	To configure <u>input</u> type See also example 4.4.2.1. NOTE: <i>After selecting an input type, do not forget to adjust the setpoint limits in Full Access level.</i>	JtC	<u>J</u> thermocouple	Defined by the ordering code, otherwise ktC <i>* If a different custom input is supplied, none will be replaced by the reference number shown in the ORDERING CODE section 5</i>	
		ktC	<u>K</u> thermocouple		
		LtC	<u>L</u> thermocouple		
		rtC	<u>R</u> thermocouple		
		btC	<u>B</u> thermocouple		
		ntC	<u>N</u> thermocouple		
		ItC	<u>I</u> thermocouple		
		StC	<u>S</u> thermocouple		
		PL 2	Platinell <u>II</u>		
		nonE	Custom downloaded input		
rtD	100Ω Platinum resistance thermometer				
mU	Linear <u>m</u> illivolt				
uolt	Linear <u>v</u> oltage				
mA	Linear <u>m</u> illiamps				
Sr U	<u>S</u> quare <u>r</u> oot <u>v</u> olts				
Sr A	<u>S</u> quare <u>r</u> oot <u>m</u> illiamps				
See 15-point CuSt list	mUC	16-point <u>m</u> illivolt <u>c</u> ustom linearisation			
	UC	16-point <u>v</u> oltage <u>c</u> ustom linearisation			
	mAC	16-point <u>m</u> illiamp <u>c</u> ustom linearisation			
CJC	Cold junction compensation (<i>CJC does not appear for Process or RTD inputs.</i> <i>For process see 'Linear input scaling' below</i>)	Auto 0°C 45°C 50°C OFF	<u>A</u> utomatic compensation <u>0</u> °C external reference <u>45</u> °C external reference <u>50</u> °C external reference No cold junction compensation	Auto	
I mP	Input <u>i</u> mpedance threshold for sensor break alarm	OFF	Sensor break alarm disabled	Auto	
		Auto	If the sensor impedance exceeds this value, sensor break alarm activates		
		H_i H_i H_i			
Linear input scaling (-9.99 to +80.00mV). These parameters appear after <I nPt> whenever <mU> , <uolt> , <mA> , <Sr U> or <Sr A> are chosen as the input type. This allows for the low and high displayed values to be set up against the corresponding electrical input values.					
TYPE	Type of calibration (see 3.3.5.)	OFF Shnt LdC CmP mAn	Off Shunt Load Cell Comparison Manual		
band	Settling <u>b</u> and. The indicator automatically determines when the input has become stable by continuous sampling. When the average value between two consecutive samples is within the settling band the indicator will then allow calibration to take place. If readings are not stable within this period the indicator will abort the calibration	0-99.99	0-99.99	0.5	
The following parameters appear for process inputs and allow the display to be calibrated to the electrical input. See also example 4.5.2.2.					
I nPL	Electrical <u>i</u> nput <u>l</u> ow	- 100.0 to 100.0 mV		0.0	
I nPH	Electrical <u>i</u> nput <u>h</u> igh	0.0 to 20.0 mA 0.0 to 10.0 Volts		100.0 if mV 20.0 if mA 10.0 if volts	
VAL L	Displayed <u>v</u> alue <u>l</u> ow	-9999 to 99999		Defined by the SP limits in ordering code, else 0	
VAL H	Displayed <u>v</u> alue <u>h</u> igh	-9999 to 99999		Defined by the SP limits in ordering code, else 100	

4.5.2.1 Example: To Select a Different Thermocouple Type

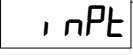
Do This	This Is The Display You Should See	Additional Notes
Enter configuration level as described in section 4.2.1.		
1. Press  until the 'Input List' header is shown		
2. Press  until <I nPt> is shown	2 secs 	 The display will return to <I nPt> after approximately 2 seconds
3. Press  or  to select the input type		















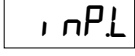

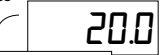

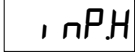

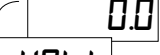
Notes:

The next parameter is cold junction compensation, <[JC]>. It is used to compensate for ambient temperature changes measured at the point at which the thermocouple (or compensating) cable connects to the indicator. Automatic, Auto, measures the temperature at the rear terminals and compensates for any ambient temperature changes. It will only be necessary to change the <[JC]> parameter if an external temperature reference source is to be used.

Sensor break is measured by the impedance, <I mP>, of the sensor circuit and an alarm is given if this is greater than a set amount. For thermocouples set this to <Auto>. For certain types of sensor its working impedance may be greater than the 1.5KΩ set by Auto. It will only be necessary to change <I mP> if this type of sensor is to be used.

4.5.2.2 Example: To Adjust Display Reading for a Process Type Input

This example is 4 - 20mA input to read 0 to 100 on the display

Do This	This Is The Display You Should See	Additional Notes
Enter configuration level as described in section 4.2.1.		
The mA input is selected in the same way as the thermocouple input above.		
1. In the input list press  until <I nPL> is shown	2 secs 	
2. Press  or  to set the low input eg 4mA		
3. Press  until <I nPH> is shown	2 secs 	
4. Press  or  to set the high input eg 20mA		
5. Press  until <UALL> is shown	2 secs 	
6. Press  or  to set the low displayed value eg 0.0		
7. Press  until <UALH> is shown	2 secs 	
8. Press  or  to set the low displayed value eg 100.0		 The display will return to <I nPt> after approximately 2 seconds

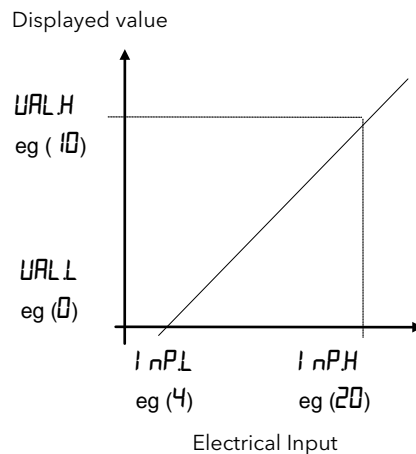

4.5.3 Alarm Configuration

Alarms are used to alert an operator when the process value has exceeded a pre-set level or when some other fault condition has occurred. They normally switch an output - usually relay - to provide an interlock on a machine/process or audio/visual indication to an operator.

The Model 2408/ has four internal 'soft' alarms which are configured in the <AL> list below. A soft alarm means indication only. To make a soft alarm activate a physical output it must be 'attached' to that output. See: section 4.5.8. 'Relay Output Configuration'

ALARM DEFINITIONS: The following alarm types can be configured:







- Full Scale High The Process Value is above a set high level
- Full Scale Low The Process Value is below a set low level
- Deviation band The difference between setpoint and the process value is outside a set band
- Deviation high The difference between setpoint and the process value is above a set value
- Deviation low The difference between setpoint and the process value is below a set value
- Rate of change The Process Value is changing faster than a set rate

AL	Alarm list	Option	Meaning	Default setting	Customer setting			
					1	2	3	4
AL 1	To select Alarm 1 Type	OFF	The alarm is disabled	Defined by the ordering code, otherwise OFF	Alarm number			
		FSL	Full Scale Low alarm - main process value					
		FSH	Full Scale High alarm - main process value					
		dEu	Deviation band alarm - main process value					
		dHi	Deviation High alarm - main process value					
		dLo	Deviation Low alarm - main process value					
		du 1	Deviation band alarm - input 1					
		dH 1	Deviation High alarm - input 1					
		dL 1	Deviation Low alarm - input 1					
		du 2	Deviation band alarm - input 2					
		dH 2	Deviation High alarm - input 2					
		dL 2	Deviation Low alarm - input 2					
		FL 2	Full Scale Low alarm on Process Value input 2					
		FH 2	Full Scale High alarm on Process Value input 2					
		LSP	Master Setpoint Low alarm					
		HSP	Master Setpoint High alarm					
		FL 1	Full scale low alarm on linearised input 1					
		FH 1	Full scale high alarm on linearised input 1					
rAL	Rate of change alarm, minutes - main PV							
rAS	Rate of change alarm, seconds - main PV							
rt 1	Rate of change alarm, minutes - input 1							
rS 1	Rate of change alarm, seconds - input 1							
rt 2	Rate of change alarm, minutes - input 2							
rS 2	Rate of change alarm, seconds - input 2							
Lch	To select alarm latching type	no	Non-latching	no				
		YES	Latched with automatic resetting (See note 1)					
		Event	Event output (See note 3)					
bLoc	To select alarm blocking	no	No blocking	no				
		YES	Blocked until first good (See note 4)					
Sbr.t	To inhibit process alarms in sensor break	d, SA	Disabled. Inhibits alarms (See note 5)	EnAb				
		EnAb	Enabled. Alarms operate when in sensor break					

The above sequence is repeated for: <AL 2> (alarm 2), <AL 3> (alarm 3) and <AL 4> (alarm 4)

- Note 1 **Automatic Resetting** means that, once the alarm has been acknowledged, it will automatically clear when it is no longer true
- Note 2 **Manual resetting** means that the alarm must first clear before it can be reset
- Note 3 **Events** can be used to operate an output in the same way as an alarm but will NOT flash an alarm message, and can be used to trigger external events. For example, an event output could be used to open/close a vent at a pre-set temperature
- Note 4 **Blocking Mode.** After power on, the process value must first enter a good state before the alarm becomes active. When once this process has been completed the alarm operates in its normal mode and does not become relevant again until power to the indicator is turned off and on again. This is particularly useful for low alarms which can be 'blocked' while the process is warming up. It is advised that blocking alarms are not used with rate of change alarms
- Note 5 **Sbr.t** When this parameter is set to 'Disabled', all alarms from the process will be inhibited should a sensor break condition occur. When Enabled process alarms will be shown (as in previous software versions) even in a sensor break condition.

Example: To Configure Alarm 2 to Operate When Input 2 Exceeds A Set Value

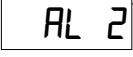
Do This	This Is The Display You Should See	Additional Notes
Enter configuration level as described in section 4.2.1.		
1. Press  until the 'Alarm List' header is shown		
2. Press  until <AL 2> is shown		 The display will return to <AL 2> after approximately 2 seconds
3. Press  or  until <FH2> is shown		<FH2> is Full Scale High alarm on input 2

The next two parameters - Alarm Latching and Alarm Blocking may be set in the same way if they are required.

4.5.4 Alarm Inhibit

The alarm inhibit feature may be used to prevent any alarms from being indicated until a 'noisy' process variable has settled. Alarm inhibit is activated by a digital input on either Digital Input 1 or 2 - see section 4.5.4. When the digital input is turned to OFF any alarms which are active will be displayed. If a delay has been set on the alarm, the delay period will start from the time when the input is turned OFF. Entering Alarm Inhibit resets both the alarm delay timer and latched alarms.

The action of Alarm Inhibit is shown in the diagram below for a Full Scale High Alarm.

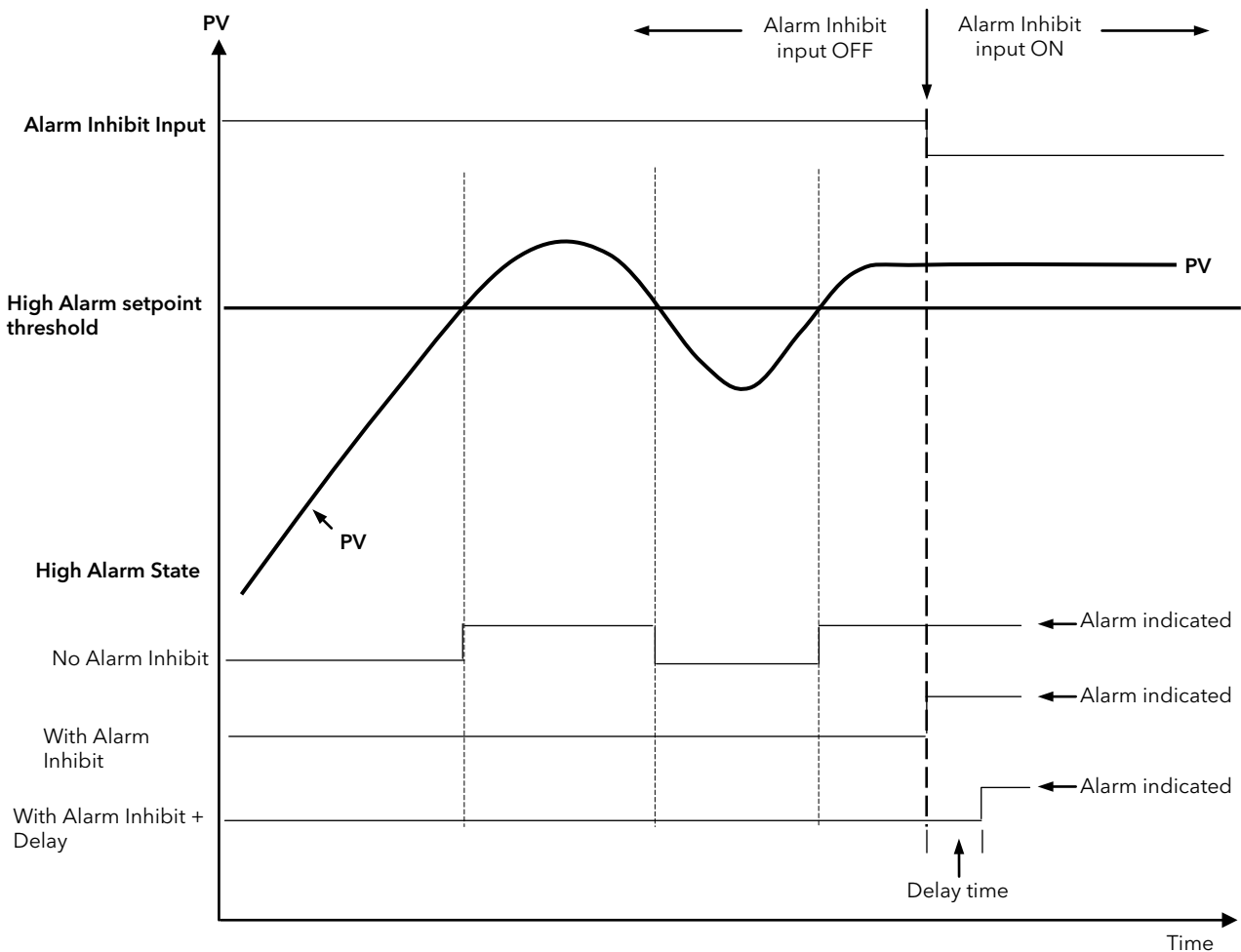



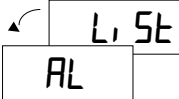



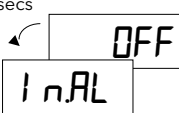



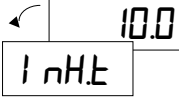

Figure 4-4: Effect of Alarm Inhibit

4.5.5 2408i Indicator With Alarm Inhibit Timer

2408i indicators fitted with software versions 3 and greater contain an alarm inhibit timer which is used to inhibit alarms for a set period after power-up and when a digital input is closed.

4.5.5.1 Operation

In the 'AL' list in Operator Level there are two parameters associated with the inhibit function see section 3.3.2. These are the alarm inhibit status 'InAL' and the inhibit time 'InHt'. To adjust the alarm inhibit time:-

Do This	This Is The Display You Should See	Additional Notes
1. In Operator Level, press  as many times as necessary to select 'AL'	2 secs 	Press  or  to show 'L 5t' if required. The display will revert to 'AL' after 2 seconds
2. Press  to read 'InAL'	2 secs 	This sets the Alarm Inhibit status: On/OFF. The display will revert to 'InAL' after 2 seconds
3. Press  or  to select 'On' or 'OFF'		
4. Press  to read 'InHt'	2 secs 	This sets the Alarm Inhibit Time 0 to 999.9 seconds. The display will revert to 'InHt' after 2 seconds
5. Press  or  to select the Alarm Inhibit Time		





On power up alarms will be inhibited for the set time. When the inhibit time is set to OFF, the timed inhibit is disabled.

4.5.5.2 Configuration of Digital Inputs for Alarm Inhibit

Two digital input functions can be configured for the alarm inhibit.

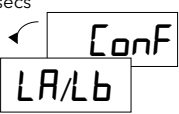
Permanent alarm inhibit

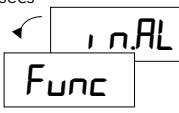

The permanent inhibit function 'InAL' is level triggered. It permanently inhibits all alarms when closed and enable all alarms when open.

Do This	This Is The Display You Should See	Additional Notes
1. In Configuration Level, press  as many times as necessary to select 'LA' or 'LB' - the digital inputs. See also section 4.5.6.	2 secs 	Digital input configuration
2. Press  to read 'Func'	2 secs 	Level triggered alarm inhibit
3. Press  or  to select 'InAL'		Please note: when using this function ensure that the inhibit timer is set to OFF.

Timed alarm inhibit

The timed inhibit function 'tmAL' is edge triggered. It will start the inhibit timer when closed and do nothing when opened. Alarms will be inhibited during the timing period at the end of which they will be enabled again.

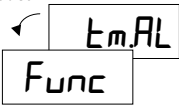
From stage 1 above:-

Do This	This Is The Display You Should See	Additional Notes
4. Press  to read 'Func'	2 secs 	Timed alarm inhibit
5. Press  or  to select 'InAL'		

4.5.6 Digital inputs 1 and 2 Configuration

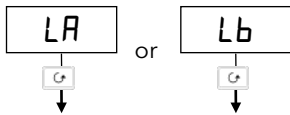

LA	Digital input 1	Option	Meaning	Default setting	Customer setting
Lb	Digital input 2				
<i>i d</i>	Identity of input	<i>LoGj</i>	Logic input	<i>LoGj</i>	Read only
<i>Func</i>	Function	<i>nonE</i>	Function not configured	<i>nonE</i>	
		<i>rmE</i>	Remote setpoint select		
		<i>AcAL</i>	Alarm acknowledge		
		<i>Acc5</i>	Select full access level		
		<i>Loc.b</i>	Keylock (disables all front panel buttons except the ACK/RESET button)		
		<i>uP</i>	Simulate pressing of the button		
		<i>dwn</i>	Simulate pressing of the button		
		<i>ScrL</i>	Simulate pressing of the button		
		<i>PAGE</i>	Simulate pressing of the button		
		<i>PUSL</i>	Process value select.		
			Closed = input 1 Open = input 2		
		<i>tAr.1</i>	Initiate automatic tare calibration of input 1		
		<i>tAr.2</i>	Initiate automatic tare calibration of input 2		
		<i>PtL.1</i>	Start the calibration at point 1, normally the low point		
		<i>PtL.2</i>	Start the calibration at point 2, normally the low point		
		<i>PtH.1</i>	Start the calibration at point 1, normally the high point		
		<i>PtH.2</i>	Start the calibration at point 2, normally the high point		
		<i>i nAL</i>	Alarm inhibit (often used in conjunction with transducer calibration to prevent alarms during the calibration process)		
		<i>PHLd</i>	Peak hold		
		<i>HLd 1</i>	Sample and Hold on PV input 1		
		<i>HLd 2</i>	Sample and Hold on PV input 2		
		<i>UCAL</i>	Enables calibration access for <i>CAL 1</i> and <i>CAL 2</i> lists		

4.5.6.1 Example: To Configure Digital Input 'A' for Tare Calibration

Do This	This Is The Display You Should See	Additional Notes
Enter configuration level as described in section 4.2.1.		
1. Press until the <LA> List' header is shown		
2. Press until the <Func> is shown	2 secs 	The display will return to <i>Func</i> after approximately 2 seconds
3. Press or until <tAr. 1> is shown		When a connection is made between rear terminals LC and LA a tare calibration is initiated.

The same procedure applies to any other option shown in the Digital Inputs table and also to the second digital input which uses list <Lb>.

4.5.7 Peak Hold and Sample and Hold

Peak Hold logs the maximum and minimum values that the indicator reads during a particular process. The peak hold value can be displayed as the main front or back display parameter, as described in section 2.1.2.

Sample and Hold logs the reading at the moment that the digital input becomes true.

Both functions are initiated by turning digital input 1 or digital input 2 to ON. They are edge triggered, so to reset and re-start, the input must be turned OFF and ON again, as detailed in Figure 4.5 below.

The values may be read in two ways:-

1. From Information List $\langle nF0 \rangle$ as:-

$\langle LOGL \rangle$ Minimum process variable

$\langle LOGH \rangle$ Maximum process variable

$\langle LOGA \rangle$ Average process variable

These values are reset when the parameter $\langle rESL \rangle$ in the $\langle nF0 \rangle$ list is turned to $\langle YES \rangle$, or the indicator power is cycled.

2. Maximum and minimum values can be promoted to the main front or back display as $\langle PUHi \rangle$ or $\langle PULo \rangle$, see section 2.1.2. They are reset when the power to the controller is cycled or by setting the values of $\langle LOGL \rangle$ and $\langle LOGH \rangle$ to zero in the $\langle nF0 \rangle$ list.

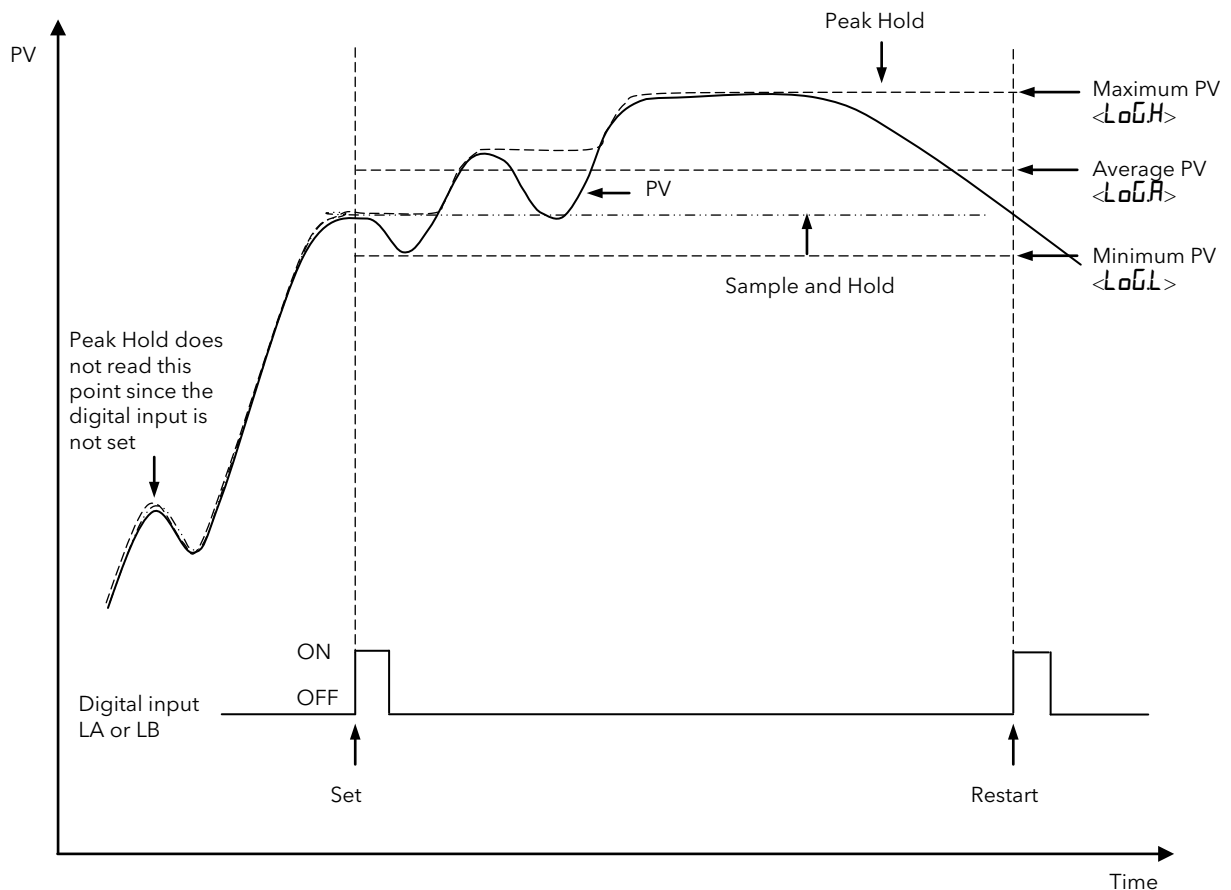
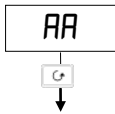

Figure 4-5: Action of Sample and Hold and Peak Hold

4.5.8 Relay Output 1 Configuration

The controller can be supplied so that Relay 1 will operate when a particular alarm occurs. This will be defined in the order code, see section 5.

This list defines which of the internal 'soft' alarms are attached to relay output 1. It is possible to attach more than one alarm to operate this relay. The procedure is described below:-



AA	Relay output 1	Option	Meaning	Default setting	Customer setting
<u>i</u> <u>d</u>	<u>I</u> <u>d</u> entity of output	<u>r</u> <u>E</u> <u>L</u> <u>Y</u>	Relay	<u>r</u> <u>E</u> <u>L</u> <u>Y</u>	Read only
<u>F</u> <u>u</u> <u>n</u> <u>c</u>	<u>F</u> <u>u</u> <u>n</u> <u>c</u> tion of output	<u>n</u> <u>o</u> <u>n</u> <u>e</u>	None Output disabled	<u>d</u> <u>i</u> <u>G</u>	
		<u>d</u> <u>i</u> <u>G</u>	Digital alarm output. Output enabled		
<u>S</u> <u>E</u> <u>n</u> <u>S</u>	<u>S</u> <u>e</u> <u>n</u> <u>s</u> e of the output.	<u>n</u> <u>o</u> <u>r</u>	Normal (relay energised in alarm)	<u>i</u> <u>n</u> <u>u</u>	
		<u>i</u> <u>n</u> <u>u</u>	Inverted (relay de-energised in alarm)		

To Attach Alarms to the Relay Output.

Any combination of the following alarms can be attached to relay output 1.

Press to select a particular alarm.

Press or to select **YES** if you want it to activate the relay. Select **no** to disconnect a given alarm.

These parameters only appear if **Func = di G**

1----	Alarm 1	YES / no		YES	
2----	Alarm 2	YES / no		no	
3----	Alarm 3	YES / no		no	
4----	Alarm 4	YES / no		no	
<u>S</u> <u>b</u> <u>r</u>	<u>S</u> <u>e</u> <u>n</u> <u>s</u> or <u>b</u> <u>r</u> eak alarm	YES / no		no	
<u>S</u> <u>P</u> <u>A</u> <u>n</u>	<u>S</u> <u>p</u> <u>a</u> <u>n</u> The Process value exceeds the display limits	YES / no		no	
<u>r</u> <u>m</u> <u>t</u> <u>F</u>	<u>R</u> <u>e</u> <u>m</u> <u>o</u> <u>t</u> e failure. Either PDS remote setpoint input, OR 2nd analogue input open circuit	YES / no		no	
<u>i</u> <u>P</u> <u>I</u> <u>F</u>	<u>I</u> <u>n</u> <u>p</u> <u>u</u> <u>t</u> 1 fail	YES / no		no	
<u>n</u> <u>w</u> <u>A</u> <u>L</u>	<u>N</u> <u>e</u> <u>w</u> <u>a</u> <u>l</u> <u>a</u> <u>r</u> <u>m</u>	YES / no		no	

1. The three dashes correspond to the alarm type set in the **<AL>** list. If the alarm is disabled, **<AL 1>** or **<AL 2>** or **<AL 3>** or **<AL 4>** will be shown.

4.5.8.1 Example 1: To Attach Alarm 1 to Relay Output AA

It is recommended that an external device is connected so that an alarm condition is indicated when the relay is de-energised. In this way if the indicator is removed or its power is removed an alarm is indicated.

To achieve this set relay sense to inverted operation.

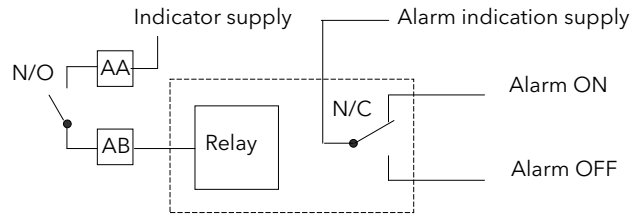

Figure 4-6: Example External Alarm Wiring

Do This	This Is The Display You Should See	Additional Notes
Enter configuration level as described in section 4.2.1. and configure Alarm 1 to the required type - see example 4.4.3.1.		
1. Press until the <AA> List header is shown		
2. Press until the <Func> is shown		The display will return to <Func> after approximately 2 seconds
3. Press or to select <di G>		
4. Press until the <SEnS> is shown		
5. Press or to select <nu>		
6. Press until the <1---> is shown		When alarm 1 is active the AA relay connected to terminals AA and AB will operate
7. Press or to select <YES>		

4.5.8.2 Example 2: To Operate Relay 1 of a Dual Relay Output Module Fitted in Slot 2 when Both Alarms 2 and 3 are Active

The wiring should be as shown in Section 1.3 using rear terminals 2A and 2B

Do This	This Is The Display You Should See	Additional Notes
Enter configuration level as described in section 4.2.1. and configure Alarms 2 and 3 to the required types - see example 4.4.3.1.		
1. Press until the <2A> List' header is shown		
2. Repeat steps 3 to 5 above		
3. Press until the <2---> is shown		The display will return to <2---> after approximately 2 seconds
4. Press or to select <YES>		
5. Press until the <3---> is shown		The display will return to <noPE> after approximately 2 seconds
6. Press or to select <YES>		Relay 1 of module 2 will operate when either Alarm 2 or Alarm 3 is active
		This procedure can be repeated for all alarms which require to operate an output relay.
		Notes: Logic module outputs can also be attached to alarms
		Do not forget to say <no> to any alarm which may already be attached to an output if it is not required.

4.6 Configuration Parameter Tables - plug in modules

4.6.1 Communications Module

The 2408*i* indicator can be fitted with the following digital communications modules:-

Protocol	Module Fitted	Order Code
ModBus	2-wire RS485	2YM
	4-wire RS422	2FM
	RS232	2AM
EI-Bisynch	2-wire RS485	2YE
	4-wire RS422	2FE
	RS232	2AE
DeviceNet		2DN

4.6.2 Communications Parameters

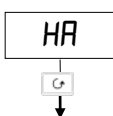





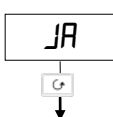





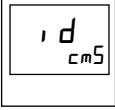

HA	Communications Module configuration	Option	Meaning	Default setting	Customer setting
<i>i d</i>	Identity of module	<i>cmS</i>	Communications	<i>cmS</i>	Read only
<i>Func</i>	Function (selects the comms. protocol)	<i>mod</i>	Modbus protocol		
		<i>EI bi</i>	EI-Bisynch protocol		
		<i>dnEt</i>	Devicenet - if the Devicenet module is fitted		
		<i>ProF</i>	Profibus - if the Profibus module is fitted		
<i>baud</i>	Selects the baud rate	<i>1200, 2400, 4800, 9600, 1920</i> (19,200)		<i>9600</i>	
<i>dELY</i>	Response delay: required by some communications adapters	<i>no</i> <i>YES</i>	No delay 10mS delay	<i>no</i>	
<i>Prty</i>	Selects the parity (Modbus only)	<i>nonE</i>	No parity	<i>nonE</i>	
		<i>EuEn</i>	Even parity		
		<i>Odd</i>	Odd parity		
<i>rES</i>	Selects the resolution (Modbus and Profibus only)	<i>FuLL</i>	Full resolution	<i>FuLL</i>	
		<i>Int</i>	Integer resolution		

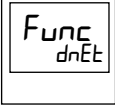
4.6.3 PDS input Module



JA	Communications Module configuration	Option	Meaning	Default setting	Customer setting
<i>i d</i>	Identity of module	<i>PdSj</i>	PDS input	<i>PdSj</i>	Read only
<i>Func</i>	Function	<i>nonE</i>	No function configured	<i>nonE</i>	
		<i>SP, P</i>	Setpoint input (to accept an input signal from a master source such as a controller with pds output)		
<i>UALL</i>	Setpoint low value	<i>-9999</i> to <i>99999</i>		<i>0</i>	
<i>UALLH</i>	Setpoint high value	<i>-9999</i> to <i>99999</i>		<i>0</i>	

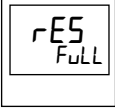





4.6.3.1 Example: To configure Function, Baud Rate, Resolution and Node Address:-

Do This	This Is The Display You Should See	Additional Notes
1. Press  as many times as necessary to select 'HA'.		This is the position in which a digital communications module is fitted
2. Press  to read 'i d'.		If the module is present 'i d' = <i>cm5</i> (digital communications) or ' <i>nonE</i> ' if the module is not present
3. Press  to read 'Func'.		If Modbus or EI Bisync module is fitted, 'Func' = ' <i>mod</i> ' or ' <i>EI bi</i> ' If Profibus module is fitted, 'Func' = ' <i>Prof</i> ' If the DeviceNet module is fitted, 'Func' = ' <i>dnEt</i> '
4. Press  to read 'bAud'.		These are read only
5. Press  or  to select the baud rate		For Modbus or EI Bisync baud rate can be set to 1200, 2400, 4800, 9600, or 19,200 For Profibus baud rate is set automatically to a maximum of 1M5 For DeviceNet baud rate can be set to 125(K), 250(K) or 500(K)
6. Press  to read 'rES'.		' <i>FULL</i> ' the decimal point position is implied, eg 100.1 is transmitted as 1001.
7. Press  or  to select 'FULL' or ' <i>int</i> '.		' <i>int</i> ' rounded to the nearest the integer value

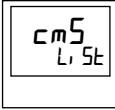
Node Address is set up in Full Access level

Exit configuration level as described in the Installation and Operation Handbook, Chapter 6.

Then:-

Do This	This Is The Display You Should See	Additional Notes
1. Press  as many times as necessary to select 'cm5'.		
2. Press  to read 'Addr'.		Valid addresses are from 0 - 63
3. Press  or  to select the address for the instrument		
4. Press  to read 'nwSt'.		Indicates the network status:- ' <i>run</i> ' = network connected and operational ' <i>rdy</i> ' = network connected but not operational ' <i>OFFL</i> ' = network not connected

4.6.4 DeviceNet Communications

The following is applicable to DeviceNet only.

4.6.4.1 The EDS File

The EDS (Electronic Data Sheet) file for the 2408*i* is named 2400.EDS and is available from your supplier, or electronically by going to Web site (www.eurotherm.com). The EDS file is designed to automate the DeviceNet network configuration process by precisely defining vendor-specific and required device parameter information. Following a data sheet metaphor, the EDS file describes a device’s configurable parameters, including its legal and default values and the public interfaces to those parameters. Software configuration tools utilize the EDS files to configure a DeviceNet network.

4.6.4.2 ODVA Compliance

This interface has been tested to comply with the full requirements of the ODVA (Open DeviceNet Vendors Association) conformity tests.

4.6.4.3 DeviceNet Wiring Connections

Terminal Reference	CAN Label	Color Chip	Description
HA	V+	Red	DeviceNet network power positive terminal. Connect the red wire of the DeviceNet cable here. If the DeviceNet network does not supply the power, connect to the positive terminal of an external 11-25 Vdc power supply.
HB	CAN_H	White	DeviceNet CAN_H data bus terminal. Connect the white wire of the DeviceNet cable here.
HC	SHIELD	None	Shield/Drain wire connection. Connect the DeviceNet cable shield here. To prevent ground loops, ground the DeviceNet network in only one location.
HD	CAN_L	Blue	DeviceNet CAN_L data bus terminal. Connect the blue wire of the DeviceNet cable here.
HE	V-	Black	DeviceNet network power negative terminal. Connect the black wire of the DeviceNet cable here. If the DeviceNet network does not supply the power, connect to the negative terminal of an external 11-25 Vdc power supply.
HF			Connect to instrument earth

-  Note: Power taps are recommended to connect the DC power supply to the DeviceNet trunk line. Power taps include:
- A Schottky Diode to connect the power supply V+ and allows for multiple power supplies to be connected.
 - 2 fuses or circuit breakers to protect the bus from excessive current which could damage the cable and connectors.
 - The earth connection, HF, to be connected to the main supply earth terminal.

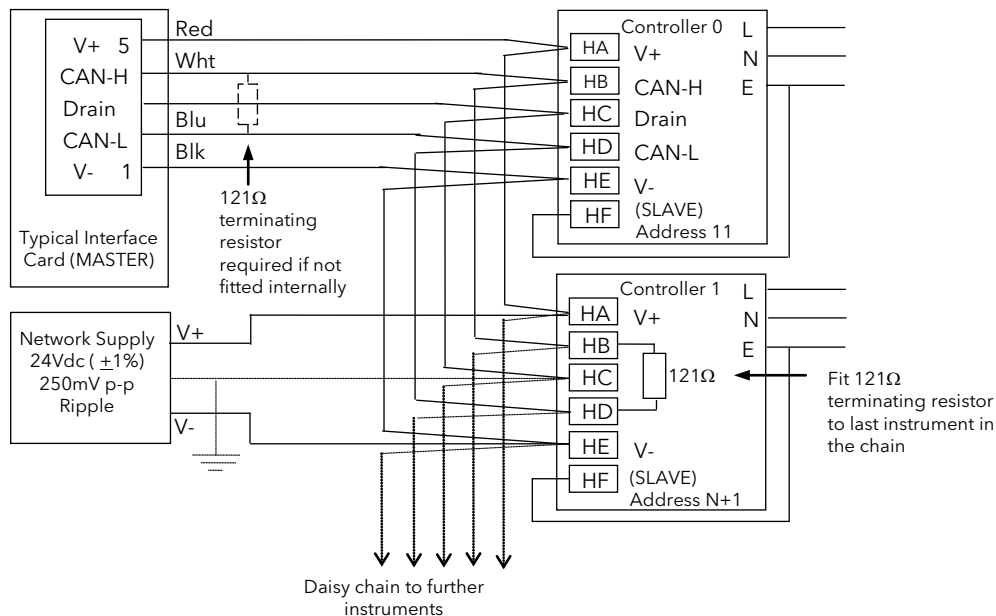

Figure 4-7: Typical DeviceNet Wiring Diagram

4.6.5 Module 1, 2 and 3 Configuration Lists

The identity of a module fitted in slots 1, 2 or 3 is shown by the first parameter in the module lists.

- If the module is a single output only channel <A> is shown
- If the module is a dual output channel <A> and channel <C> are shown
- If the module is a triple output Channel <A>, channel and channel <C> are shown

Module configuration lists are summarised below:-

1A	to	3C										
G	G											
LIST HEADINGS:			MODULE 1	MODULE 2	MODULE 3							
			1A, 1b, 1C	2A, 2b, 2C	3A, 3b, 3C	(Note: The list heading corresponds to the terminal number to which the input/output is wired)						
Note: Channel 'b' only appears if a dual or triple channel module is fitted. Channel 'C' only appears if a triple channel module is fitted												
			Customer setting in each channel number									
Module Parameters		Option	Meaning	1A	1b	1C	2A	2b	2C	3A	3b	3C
1 d	Identity of module	nonE rELY LoG LoG, dC, P dc rE tPSU SG.SU	Module not fitted Relay output Logic output Logic or contact closure input 2 nd analogue input module (Module 3 only) DC retransmission Transmitter power supply Strain gauge power supply									

4.6.6 Changeover Relay or Dual Relay Output Module





4.6.7 Triple Logic Output Module

The parameter lists are the same for each of these modules as listed below:-

1 d	Identity of module	rELY LoG	Relay Logic	Customer settings in each channel								
				1A	1b	1C	2A	2b	2C	3A	3b	3C
Func	Function of output	nonE di G	Module operation turned off Digital									
SEnS	Sense of the output	nor nu	Output energises when TRUE Output de-energises when TRUE (default for alarms)									
If Func = nonE no further parameters are shown												
1---	Alarm 1	YES / no										
2---	Alarm 2	YES / no										
3---	Alarm 3	YES / no		Alarms are								
4---	Alarm 4	YES / no		attached to the								
Sbr	Sensor break alarm	YES / no		output in the same								
SPAn	Span	YES / no		way as relay								
rm tF	Remote failure	YES / no		output 1								
1 P IF	Input 1 fail	YES / no										
nuAL	New alarm	YES / no										
The changeover relay output module has a single output so the above parameters are shown under list <-A> only The triple logic module has three outputs so the above parameters are shown under lists ' <-A>, <-b>, and ' <-C> The dual relay module has two outputs so the above parameters are shown under lists ' <-A> and <-C>												

4.6.8 Triple Logic Input or Triple Contact Closure Input Module

The triple logic input module allows further digital inputs in addition to those in the basic instrument. The list of parameters is the same as the fixed digital inputs 1 & 2, section 4.5.6. as follows:-

				Customer settings in each channel								
				1A	1b	1C	2A	2b	2C	3A	3b	3C
id	Identity of module	LOG	Logic input	Read only								
Func	Function	nonE	Function not configured									
		rmE	Remote setpoint select									
		AcAL	Alarm acknowledge									
		AccS	Select full access level									
		Locb	Keylock (disables all front panel buttons except the ACK/RESET button)									
		uP	Simulate pressing of the  button									
		dwn	Simulate pressing of the  button									
		ScrL	Simulate pressing of the  button									
		PAGE	Simulate pressing of the  button									
		PUSL	Process value select. Closed = input 1 Open = input 2									
		tAr.1	Initiate automatic tare calibration of input 1									
		tAr.2	Initiate automatic tare calibration of input 2									
		PEL.1	Start the calibration at point 1, normally the low point									
		PEL.2	Start the calibration at point 2, normally the low point									
		PEH.1	Start the calibration at point 1, normally the high point									
		PEH.2	Start the calibration at point 2, normally the high point									
		inAL	Alarm inhibit									
		PHLd	Peak hold									
		HLd1	Sample and Hold on PV input 1									
		HLd2	Sample and Hold on PV input 2									
UCAL	Enables calibration access for CAL 1 and CAL 2 lists											

The triple logic or triple contact closure module has three inputs so the above parameters are shown under lists <-A>, <-b>, and <-C>

4.6.9 DC input Module

The DC Input module can only be fitted in slot 3. The following parameters appear:-

Module Parameters	Option	Meaning	Customer settings
id	Identity of module	dC, P	DC input Read only
Func	Function	nonE	No function. Input used for monitoring and alarm only
		rSP	Remote setpoint input. When selected this becomes the setpoint for deviation alarms. In <FULL> access level, set Remote SP Enable, <L-r> = <rmt> (Remote SP selected)
		Hi	Process Value = the highest of Input 1 and input 2 is displayed in normal operation. In normal operation the display cannot be switched between 'front' and 'back' views. The reading shows the highest or lowest value only.
		Lo	Process Value = the lowest of Input 1 and input 2 is displayed in normal operation. In normal operation the display cannot be switched between 'front' and 'back' views. The reading shows the highest or lowest value only.
		Ftn	Derived value. Process Value = (<F.1> x Input 1) + (<F.2> x input 2), where <F.1> and <F.2> are scalars found in the <P> list in Full Access level. Refer to section 3.3.4. for an example of differential measurement.
		SEL	Select input 1 or input 2 via comms, a digital input, or in the Operator <P> list. If a digital input is configured use the parameter <PU.SL> . If the input is selected through the Operator list in Full Access use the parameter <PU, P>
		trAn	Transition region between <P.1> and <P.2> , set by <Lo, P> and <Hi, P> in Operator Level. See example 4.6.7.1.
If <Func> = <nonE> no further parameters are shown. When <Func> ≠ <nonE> , input 2 parameters are shown in the Input List in Full access level The parameters that follow are the same as those in the <P> configuration list plus <Hi Ln> - the high impedance input option			
inpL		Refer to <P> list section 4.5.2. plus the following parameter	Customer settings
	Hi Ln	0 to 2volt high impedance input	
CJC		Refer to <P> list	
Imp			
InPL			
ImpH			
UALL			
UALH			
TYPE	Type of calibration	oFF	Off
		Shnt	Shunt
		LdC	Load Cell
		CmP	Comparison
		mAn	Manual
bAnd	Settling band.	0-99.99 (Default 0.5)	The indicator automatically determines when the input has become stable by continuous sampling. When the average value between two consecutive samples is within the settling band the indicator will then allow calibration to take place. If readings are not stable within this period the indicator will abort the calibration
The DC input module has a single input so the above parameters are shown under list <PA> only			

4.6.9.1 Example: Input 1 and Input 2 are Configured for Transition

An example of the use for this could be the measurement of temperature over a wide range. The lower temperatures may be measured by a base metal thermocouple connected to Input 1 and higher temperatures may be measured by a pyrometer or precious metal thermocouple connected to input 2. The reason for such a combination is to provide the most accurate readings over the full temperature range where the thermocouple cannot be used at high temperatures and the pyrometer is too insensitive at low temperatures to provide an accurate reading.

The thermocouple may be withdrawn, to prevent damage to it, using a high alarm set around the upper limit of the thermocouple.

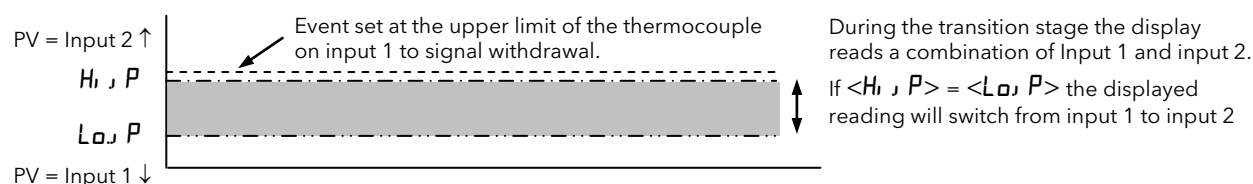

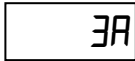

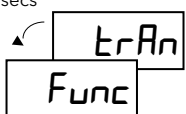









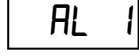

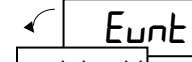



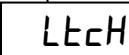

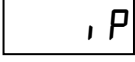

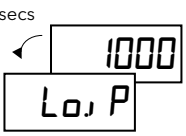



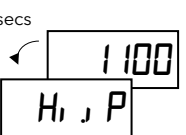



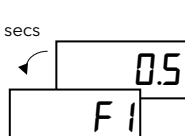



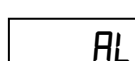

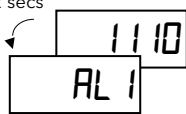



Figure 4-8: Input 1/Input 2 Transition

Do This	This Is The Display You Should See	Additional Notes
A. Configure the DC Input Module fitted in slot 3 for transition function		
1. Press  until the <3A> List header is shown		
2. Press  until <Func> is shown	2 secs 	 The display will return to <Func> after approximately 2 seconds
3. Press  or  to select <TrAn>		
B. Configure an alarm as a full scale high event		
1. Press  until the 'Alarm List' header is shown		
2. Press  to select alarm 1, 2, 3, or 4 as appropriate	2 secs 	 This configures alarm 1 for full scale high
3. Press  or  to select <FSH>		
4. Press  to select <Ltch>	2 secs 	 This configures alarm 1 for an event so that an alarm message is not displayed as the PV exceeds the alarm setpoint.
5. Press  or  to select <Event>		
C. Attach the alarm to a relay output as described in examples 4.4.5.1 or 4.4.5.2.		
D. Exit configuration level and enter Full access level to set the transition values and full scale high alarm (event) setpoint		
1. Press  until the 'Input List' header is shown		
2. Press  until the <Lo, P> is shown	2 secs 	
3. Press  or  to set a level at which the sensor on input 1 is to be phased out		
4. Press  until the <Hi, P> is shown	2 secs 	 If <Lo, P> is set to the same value as <Hi, P> the displayed reading will jump from Input 1 to input 2 at this value.
5. Press  or  to set a level at which the sensor on input 2 is to be phased in		
6. Press  until the <F 1> is shown	2 secs 	<p><F. 1> and <F.2> are constants to achieve a derived PV where PV = <F. 1> x input 1 + <F.2> x input 2</p> <p>As the displayed reading, in normal operation, moves between Input 1 and input 2 it will do so in a controlled manner. Some experiment may be necessary with the four parameters to achieve ideal settings.</p>
7. Press  or  to set a multiplying factor on input 1 if necessary		
8. Repeat for <F2>		
9. Press  until the 'Alarm List' header is shown		
10. Press  until the <AL 1> is shown	2 secs 	
11. Press  or  to set the level at which the base metal thermocouple is to be removed		

4.6.10 DC Retransmission Module

The following parameters appear.

Module Parameters		Option	Meaning	Customer settings		
				1A	2A	3A
ID Func	Identity of module Function	dcrE	DC retransmission			
		nonE	None configured			
		PU	Process value retransmission			
		wSP	Setpoint retransmission			
		Err	Error from setpoint retrans.			
		IP.1	Input 1 retransmission			
		IP.2	Input 2 retransmission			
If Func = nonE no further parameters are shown						
URLL			Retransmission value low			
URLH			Retransmission value High			
Unit			Electrical output units uolt = Volts, mA = milliamps			
OutL			Minimum electrical output			
OutH			Maximum electrical output			
The DC retransmission module has a single output so the above parameters are shown under list -A only						

4.6.10.1 Example: To Scale the DC Retransmission Output

The retransmission output can be scaled so that the output value corresponds to the range of the signal to be transmitted.

Figure 4.5 shows an example where the retransmitted signal is <PU> or <wSP> and an electrical output of 4-20mA represents a displayed value of 20.0 to 200.0 units.

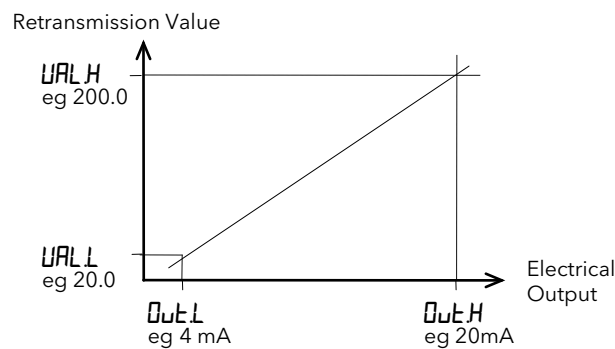

Figure 4-9: Scaling a Retransmission Output

4.6.11 Strain Gauge Transducer Supply

The following parameters appear:-

Module Parameters		Option	Meaning	Customer settings		
				1A	2A	3A
ID	Identity of module	SG.SU	Strain Gauge supply			
Func	Function	nonE	None			
		IP.1	Bridge supply for input 1			
		IP.2	Bridge supply for input 2			
brGU	Bridge voltage	5	5 volt bridge supply			
		10	10 volt bridge supply			
SHnt	Calibration shunt resistor	Ext	External shunt resistor used			
		Int	Internal shunt resistor used			
The strain gauge transducer module has a single input so the above parameters are shown under list -A only						

4.6.12 Transmitter Power Supply

The following parameters appear:-

Module Parameters		Option	Meaning
ID	Identity of module	TP.SU	Transmitter power supply
Func	Function	nonE	Fixed 24Vdc 20mA supply

4.7 Indicator calibration

This section explains how to calibrate PV inputs 1 and 2, and retransmission outputs. It should not be confused with User Calibration described in section 3.6 which allows the user to add offsets to compensate for external measurement inaccuracies. Calibration of the indicator should not normally be necessary and must only be carried out using calibrated reference sources. It is always possible to revert to factory calibration settings if necessary.

4.7.1 To Calibrate Input 1 or 2

- A mV calibration should be carried out before thermocouple and RTD calibrations.
- Connect a mV, volt source to the input which you wish to calibrate.
- If the input is RTD connect a resistance box.

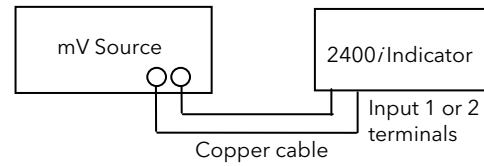

Figure 4-10: mV Input Calibration

4.7.1.1 To Calibrate mV or Volt Inputs:-

Do This	This Is The Display You Should See	Additional Notes
1. From any display press as many times as necessary to access the <CAL> List' header		
Set the mV source to 0.000mV		
2. Press to show <rcAL>		
3. Press or to select input 1 or 2 <PU.1> or <PU.2>		For 0 - 10V input range and high impedance input range, set the volt source to 0.000V
4. Press to show <PU>		
5. Press or to select <muL>		This allows you to choose the parameter to be calibrated
6. Press to show <GO>		
7. Press or to select <YES>		 When the indicator is calibrating the message <buSY> is shown. When complete the message <done> is flashed briefly and the display returns to <GO>. The low point calibration is now complete
Set the mV source to 10.000mV		
8. Repeat the above steps for <muH>		For 0 - 10V input range, set the volt source to 10.000V For RTD input range, set the resistance box to 400.00Ω For high impedance input range, set volt source to 1.000V

4.7.1.2 To Calibrate CJC

In addition, for thermocouple inputs, calibrate Cold Junction Compensation (CJC), as follows:-

Do This	This Is The Display You Should See	Additional Notes
1. Replace the copper cable from the mV source with the appropriate compensating cable		
2. Configure the indicator for a thermocouple type. A base metal thermocouple such as type K is recommended		
3. Set the mV source to the same thermocouple compensation		
4. Set the mV source to 0.000mV		
5. From the <PU> list press or as many times as necessary to access <CJC>		
6. Press to show <GO>		
7. Press or to select <YES>		 When the indicator is calibrating the message <buSY> is shown. When complete the message <done> is flashed briefly and the display returns to <GO>. The CJC calibration is now complete.

4.7.2 To Calibrate Retransmission Output

Connect the retransmission output to a multi-meter set to volts or mV as appropriate.

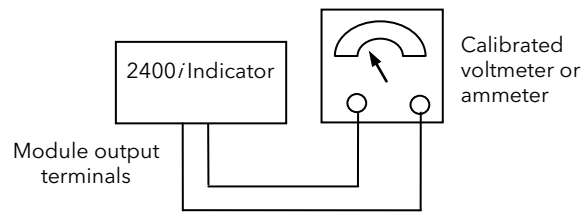

Figure 4-11: Retransmission output calibration

Do This	This Is The Display You Should See	Additional Notes
1. From the <rcAL> list press or as many times as necessary to select the module to be calibrated, e.g. <IAH1>		In this example module 1 will be calibrated. The high output is calibrated first
2. Press to show <CALH>		The reading on the indicator can be adjusted between -999 and +999. This is an arbitrary value which acts as a trim on the output
3. Press or to adjust the required output read on the meter		
4. Press to select the <rcAL> list		The low output is calibrated next
5. Press or as many times as necessary to select the module to be calibrated, e.g. <IAL0>		
6. Press to show <CALL>		The reading on the indicator can be adjusted between -999 and +999. This is an arbitrary value which acts as a trim on the output
7. Press or to adjust the required output read on the meter		

4.7.3 To Restore Factory Calibration

Factory calibration of PV input and PV input 2 can be restored as follows:-

Do This	This Is The Display You Should See	Additional Notes
1. From the <PU> list press or as many times as necessary to select <FACT>		The factory set calibration values are restored

4.7.4 Calibration Parameters

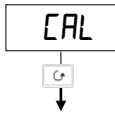

CAL	Basic Indicator Calibration		Selected parameter
rCAL	Selected <u>re</u> -calibration parameter	nonE PU.1 PU.2 1AH_i 1AL_o 2AH_i 2AL_o 3AH_i 3AL_o	Idle state - no calibration performed Main process value input selected Second analogue input selected (this will always be in module position 3) Module 1 DC retransmission high output (if installed) Module 1 DC retransmission low output (if installed) Module 2 DC retransmission high output (if installed) Module 2 DC retransmission low output (if installed) Module 3 DC retransmission high output (if installed) Module 3 DC retransmission low output (if installed)
If rCAL = PU.1 or PU.2 the following parameters appear:			Calibration point
PU	PU or PU.2 calibration point	IDL mV.L mV.H U 0 U 10 CJC rtd HI 0 HI 10 FACT	Idle mV low calibration point selected mV high calibration point selected 0 Volt calibration point selected 10 Volt calibration point selected Cold junction calibration Resistance input calibration High impedance input. 0 Volt calibration point selected High impedance input. 1.0 Volt calibration point selected Restore factory calibration selected
GO	Start calibration	no YES buSY donE FAI.L	Waiting to calibrate PV point Start calibration Busy calibrating Calibration complete Calibration failed
If rCAL = 1AH_i to 3AL_o (DC output module calibration) the following parameters appear:			
cALL	DC output <u>cal</u> ibration_ <u>low</u> point	0	0 = Factory cal. Trim value to give output = + 1V or +2mA
cALH	DC output <u>cal</u> ibration_ <u>high</u> point	0	100 = Factory cal. Trim value to give output = + 9V or +18mA

4.7.5 Password Configuration

PASS	Passwords	Range	Notes	Default setting	Customer setting
ACCP	Full and Edit level password	0-9999	When passwords are changed please make a note of the new numbers Having once entered the correct password, operator, full or edit level can be selected at will. To return to operator level and lock the indicator in this level, either switch the indicator off and on again or enter an invalid password as described in section 4.2.1.	1	
cnFP	Configuration level password	0-9999	Configuration level can only be entered from the above level. You must exit this level to return to operator level by following the exit procedure in section 4.7.6.	2	
CALP	User calibration password	0-9999	User calibration level (described in Section 3.5.1.) can be entered from operator level. To return to normal operation: Enter an incorrect password Switch power off and on again	3	

4.7.6 To Leave Configuration Level

Do This	This Is The Display You Should See	Additional Notes
1. Press to reach the <E _i E> display 2. Press or to select <YES>		After 2 secs the display will blank then return to the HOME display in Operator level

5 Ordering Code

Model number	Function	Display colour	Supply voltage	Module 1	Module 2	Module 3	Relay Output 1	Comms Module	PDS Module	Manual
2408i										

Function	
AL	Indicator/Alarm unit
AP	Profibus Indicator

Display colour	
G	Green display
N	
RD	Red display

Supply voltage	
VH	230Vac
VL	24Vac/dc

Note 1: By default, alarm 1 will be assigned to relay output 1 and alarms 2, 3 and 4 will be assigned to Modules 1, 2 and 3 respectively.

Note 2: The allocation of alarms to the dual relay outputs must be performed in configuration by the customer.

Note 3: Triple contact or logic inputs can be configured, by the user, for any of the functions listed under Digital Inputs 1 and 2.

Note 4: The triple logic output can be configured as alarm outputs or as telemetry outputs via digital communications.

Modules 1, 2 and 3	
XX	Module not fitted
Alarm Relay output (change-over)	
R4	Module fitted unconfigured
OR	Select alarm configuration from table A.
DC retransmission	
D6	Module fitted unconfigured
First character	
V-	Process Value retransmission
S-	Setpoint retransmission
Z-	Error retransmission
Second character	
-1	0-20mA
-2	4-20mA
-3	0-5Vdc
-4	1-5Vdc
-5	0-10Vdc
Dual relay (Note 2)	
RR	Module fitted unconfigured
Triple contact input (Note 3)	
TK	Module fitted unconfigured
Triple logic input (Note 3)	
TL	Module fitted unconfigured
Triple logic output (Note 4)	
TP	Module fitted unconfigured
Transmitter supply	
MS	24Vdc, 20mA supply
Strain Gauge Transducer supply (modules 1 & 2 only) (note 5)	
G3	5V transducer supply
G5	10v transducer supply
2nd analogue input (module 3 only)	
D5	Module fitted unconfigured
	For configuration, see PV Function field

Relay Output 1	
XX	Not fitted
RF	Fitted unconfigured
OR	Select alarm configuration from table A

Table A:
Alarm relay configuration
 (See note 1)

Non-latched alarms

FH	High alarm
FL	Low alarm
DB	Deviation band alarm
DL	Deviation low alarm
DH	Deviation high alarm
RA	Rate-of -change alarm

Latched alarms

HA	High alarm
LA	Low alarm
BD	Deviation band alarm
WD	Deviation low alarm
AD	Deviation high alarm
RT	Rate-of -change alarm
NW	New alarm

Note 5: By default, the transducer supply for input 1 will be installed in module position 2 and the transducer supply for input 2 in module position 1.

Comms module	
XX	Module not fitted
RS232 Module	
A2	Module fitted unconfigured
A	Modbus protocol
M	
AE	El-Bisynch protocol
RS485 (2-wire) Module	
Y2	Module fitted unconfigured
YM	Modbus protocol
YE	El-Bisynch protocol
RS485 (4-wire) (= RS422) Module	
F2	Module fitted unconfigured
FM	Modbus protocol
FE	El-Bisynch protocol
Profibus Module	
PB	High speed RS485

PDS module	
XX	Module not fitted
M6	Module fitted unconfigured
RS	Remote setpoint input

Manual	
XXX	None
ENG	English
FRA	French
GER	German
NED	Dutch
SPA	Spanish
SWE	Swedish
ITA	Italian

SOFTWARE CONFIGURATION						Configuration of 2 nd analogue input requires D5 in module 3				
Sensor Input	Setpoint min	Setpoint max	Display Units	Digital input 1	Digital input 2	2 nd DC Input	PV Function	2 nd Input Display Min	2 nd Input Display Max	Configuration option
	Note 6	Note 6				Note 7		Note 8	Note 8	

Sensor input & 2 nd DC input		Setpoint min & max			
		°C		°F	
Thermocouples					
J	Type J	Min	Max	Min	Max
K	Type K	-210	1200	-340	2192
T	Type T	-200	1372	-325	2500
L	Type L	-200	400	-325	750
N	Type N	-200	900	-325	1650
R	Type R	-250	1300	-418	2370
R	Type R	-50	1768	-58	3200
S	Type S	-50	1768	-58	3200
B	Type B	0	1820	32	3308
P	Platinell II	0	1369	32	2496
Z	Pt100	-200	850	-325	1562
Process inputs (Scaled to setpoints max & min)					
F	-100 to +100mV	Range Min		Range Max	
Y	0 to 20mA (note 2)	-9999		99999	
A	4 to 20mA (note 2)	-9999		99999	
W	0 to 5Vdc	-9999		99999	
G	1 to 5Vdc	-9999		99999	
V	0 to 10Vdc	-9999		99999	
Factory downloaded input					
C	Type C -W5%Re/W26%Re (default downloaded input)	"Table Reference Number"	0 to 2319		32 to 4200
D	Type D -W3%Re/W25%Re	"T035"	0 to 2399		32 to 4350
E	E thermocouple	"T012"	-270 to 999		-450 to 1830
1	Ni/Ni18%Mo	"T033"	0 to 1399		32 to 2550
2	Pt20%Rh/Pt40%Rh	"T025"	0 to 1870		32 to 3398
3	W/W26%Re (Engelhard)	"T09"	0 to 2000		32 to 3632
4	W/W26%Re (Hoskins)	"T029"	0 to 2010		32 to 3650
5	W5%Re/W26%Re (Engelhard)	"T011"	10 to 2300		50 to 4172
6	W5%Re/W26%Re (Bucose)	"T038"	0 to 2000		32 to 3632
7	Pt10%Rh/Pt40%Rh	"T023"	200 to 1800		392 to 3272
8	Exergen K80 I.R. Pyrometer	"Er80"	-45 to 650		-49 to 1202

Display Units			
C	°C	K	°K
F	°F	X	Blank

PV function	
XX	Input 1 displayed
LO	PV = the lowest of i/p 1 and 2
HI	PV = the highest of i/p 1 and 2
FN	PV derived from i/p 1 and 2
RS	Remote setpoint

Digital inputs 1 & 2	
XX	Disabled
AC	Alarm acknowledge
KL	Keylock
SR	Remote setpoint select
PV	Select process value input 2
M5	CTX mode 5 (digital input 2 only). For use with PDMTCX 'smart' current transformer.
J1	Initiate tare correction on strain gauge input 1
J2	Initiate tare correction on strain gauge input 2
J3	Initiate automatic calibration of strain gauge input 1
J4	Initiate automatic calibration of strain gauge input 2

Configuration Option	
XX	Standard
SG	Load cell/strain gauge
MP	pressure transducer

Note 6: Setpoint min and max: Include the decimal points required in the displayed value.

Note 7: Select the code required from the Sensor Input table.

Note 8: These two fields are used to scale the 2nd DC input if it is a linear process input, otherwise it should be left blank.

Note 9: For mA inputs, a 1% 2.49Ω current sense resistor is supplied. For greater accuracy, a 0.1% resistor can be ordered - Part No. SUB2K/249R.1.

6 Safety and EMC Information

Safety

This indicator complies with the European Low Voltage Directive 73/23/EEC, amended by 93/68/EEC, by the application of the safety standard EN 61010.

Electromagnetic compatibility

This indicator conforms to the essential protection requirements of the EMC Directive 89/336/EEC, amended by 93/68/EEC, by the application of a Technical Construction File. This indicator satisfies the general requirements of the industrial environment defined in EN 50081-2 and EN 50082-2.

General

The information contained in these instructions is subject to change without notice. While every effort has been made to ensure the accuracy of the information, your supplier shall not be held liable for errors contained herein.

Unpacking and storage

The packaging should contain the indicator, two panel retaining clips, a 2.49Ω current sense resistor and this instruction leaflet.

If the packaging or the indicator is damaged, do not install the product but contact your supplier.

This indicator has no user serviceable parts. Contact your supplier for repair.

Caution: Charged capacitors

 Before removing the indicator from its sleeve, switch off the supply and wait two minutes to allow capacitors to discharge. Failure to observe this precaution may damage the indicator or cause mild electric shock.

Precautions Against Electrostatic Discharge Damage

 When the indicator is removed from its sleeve, it is vulnerable to damage by electrostatic. To avoid this, observe anti-static handling precautions.

Cleaning

Do not use water or water based products to clean labels or they will become illegible. Isopropyl alcohol may be used to clean labels. A mild soap solution may be used to clean other exterior surfaces of the product.

Safety Symbols

The following safety symbols are used on the controller and in this manual:

 Caution, important safety information

 Functional earth (ground) terminal

 Useful information or hint

Personnel

Installation must be carried out by qualified personnel.

Enclosure of live parts

The indicator must be installed in an enclosure to prevent hands or metal tools touching parts that may be electrically live.

Caution: Live sensors

 The alarm acknowledge/keylock input is electrically connected to the sensor input (e.g. thermocouple). In some installations the temperature sensor may become live. The indicator is designed to operate under these conditions, but you must ensure that this will not damage other equipment connected to the logic input/output and that service personnel do not touch this connection while it is live. With a live sensor, all cables, connectors and switches for connecting the sensor and non-isolated inputs and outputs must be mains rated.

Wiring

 Wire the indicator in accordance with the wiring data given in these instructions. Take particular care not to connect AC supplies to the low voltage sensor input or logic outputs. Only use copper conductors for connections, (except thermocouple). Ensure that the installation complies with local wiring regulations, and observe maximum voltage safety limits.

Power Isolation

 The installation must include a power isolating switch or circuit breaker that disconnects all current carrying conductors. The device should be mounted in close proximity to the indicator, within easy reach of the operator and marked as the disconnecting device for the indicator.

Voltage rating

 The maximum continuous voltage applied between any connection and ground must not exceed 264Vac.

For the above reason the indicator should not be wired to a three-phase supply with an unearthed star connection. Under fault conditions such a supply could rise above 264Vac with respect to ground and the product would not be safe.

Conductive pollution

 Electrically conductive pollution must be excluded from the cabinet in which the indicator is mounted. For example, carbon dust is a form of electrically conductive pollution. Where condensation is likely, for example at low temperatures, include a thermostatically controlled heater in the cabinet.

Installation requirements for EMC

- For general guidance refer to EMC Installation Guide, HA025464.
- It may be necessary to fit a filter across the relay output to suppress conducted emissions. The filter requirements will depend on the type of load.

Routing of wires

To minimise the pick-up of electrical noise, the sensor input wiring should be routed away from high-current power cables. Where it is impractical to do this, use shielded cables with the shield grounded at both ends.

7 Technical Specification

Main process value input and second DC input

Low level range	-100 to +100mV
High level range	0-20mA or 0-10Vdc
Sample rate	9Hz
Resolution	<2 μ V for low level inputs <2mV for high level inputs
Linearity	Better than 0.2°C
Calibration accuracy	\pm 0.2% of reading, or \pm 1°C or \pm 1LSD, whichever is the greater
User calibration	Low and high offsets can be applied
Input filtering	OFF to 999.9 seconds
Thermocouple types	Refer to ordering code sensor input table
Cold junction compensation	In automatic mode, >30:1 rejection of ambient temperature change.
3-wire Pt100 input Bulb current:	0.3mA
Maximum lead resistance	Up to 22 Ω in each lead without error
2 nd analogue input functions	2 nd process value, remote setpoint, select min, select max, derived value
Input impedance, mV inputs	>10M Ω
Input impedance, Volt inputs	>69K Ω

Digital inputs

Contact closure or open collector inputs

Note: These are powered by the controller

Digital inputs 1 & 2 (Non isolated from PV)	Switching voltage/current: On state resistance >28K Ω
Triple contact closure inputs	Isolated. Specification as dig. inputs 1 & 2

Externally powered inputs

Triple logic inputs	Off state: <5Vdc On state: 10.8 to 30Vdc @ 2.5mA
---------------------	---

Digital input functions

As per digital inputs 1 & 2 in the ordering code

Digital outputs

Relay rating	2A, 264Vac resistive
Triple logic output	8mA, 12Vdc per channel
Digital output functions	as per the ordering code

DC retransmission

Range	Scaleable between 0-20mA and 0-10Vdc
Resolution	1 part in 10,000
Retransmission values	Process value, setpoint or error from

Transmitter supply

Rating	20mA, 24Vdc
--------	-------------

Strain gauge bridge supply

Bridge voltage	Software selectable, 5 or 10Vdc
Bridge resistance	300 Ω to 10K Ω
Internal shunt resistor	30.1K Ω at 0.25%, used for calibration of 350 Ω bridge

Alarms

Number of alarms	Four
Alarm types	High, low, deviation high, deviation low, deviation band, rate of change in units/sec, rate of change in units/min, new alarm status. Sensor break alarm
Alarm modes	Latching or non-latching. Blocking Energised or de-energised in alarm
Alarm delay	OFF to 999.9 seconds

Communications

Module types	RS232, 2-wire RS485 and 4-wireRS485
Protocols	Modbus® or EI-Bisynch (ASCII) Devicenet Profibus

PDS

Functions	Remote setpoint input from master controller
-----------	--

General

Display colour	Red or green options
Number of digits	Five with up to three decimal places
Supply	100 to 230Vac \pm 15%, 48 to 62Hz or 24Vac, 48 to 62Hz, -15%+10% or 24 Vdc -15%+20%
Power consumption	15W max
Operating ambient	0 to 55°C and 5 to 95% RH non-condensing
Storage temperature	-10 to +70°C
Panel sealing	IP65, NEMA12
Dimensions	96W x 48H x 150D
Weight	400g max
EMC Standards:	EN50081-2 & EN50082-2 generic standards for industrial environments
Safety standards	Meets EN 61010, Installation category II, pollution degree 2.
Atmospheres	Not suitable for use above 2000m or in explosive or corrosive atmospheres

