

1.	2604CP FURNACE ATMOSPHERE CONTROLLER/PROG2	
1.1	INTRODUCTION	2
1.1.1	Related Handbooks	2
1.2	WHAT IS CARBON POTENTIAL CONTROL	3
1.2.1	Zirconia Probe.....	3
1.2.2	Dewpoint.....	3
1.2.3	Sooting Alarm and Probe Burn Off.....	4
1.3	TYPICAL FUNCTION BLOCK DIAGRAM.....	4
1.4	INSTALLATION.....	5
1.5	WIRING CONNECTIONS.....	5
1.5.1	Controller Connections to Plant Devices	6
1.5.2	IO Expander Connections to Plant Devices	7
1.6	TEMPERATURE/ZIRCONIA CONTROL.....	8
1.6.1	To Change Temperature Setpoint.....	8
1.6.2	To Change to the Carbon Setpoint	8
1.6.3	To Select Auto or Manual Operation	8
1.6.4	Alarm Messages	9
1.6.5	Operator Buttons.....	10
1.7	SETPOINT PROGRAMMER.....	11
1.7.1	Setpoint Programmer Block Diagram	11
1.7.2	Programmer Type.....	12
1.7.3	To Select, Run, Hold or Reset a Program	12
1.7.4	To Create or Edit a Program	14
1.7.5	PROGRAM EDIT (Program Page) Parameters	15
1.7.6	To Set Up Each Segment of a Program.....	16
1.7.7	PROGRAM EDIT (Segment) Parameters	19
1.7.8	To Edit A Running Program	21
1.7.9	Run Parameters	22
1.8	ACCESS	24
1.8.1	To Select Access Level 3	24
1.9	ALARMS.....	25
1.9.1	To Activate/Deactivate Alarms	25
1.10	PROBE IMPEDANCE.....	26
1.10.1	To Calibrate High Impedance Input	26
1.10.2	Alarm Inhibition.....	27
1.10.3	Impedance Measurement Filter	27
1.11	ORDERING CODE.....	28
1.11.1	Ordering Code for the IO Expander	29

1. 2604CP Furnace Atmosphere Controller/Prog

1.1 INTRODUCTION

The 2604CP Furnace Atmosphere Controller/Programmer is a fully programmable controller suitable for precision control of temperature, carbon potential, dewpoint and oxygen in atmosphere heat treatment applications. It may be supplied with the following clone files:-

Clone File Name	Function
26CP-CXX-V1.xx.UIC	carbon potential only
26CP-DXX-V1.xx.UIC	dewpoint only
26CP-OXX-V1.xx.UIC	oxygen only
26CP-CTX-V1.xx.UIC	carbon potential plus temperature
26CP-DTX-V1.xx.UIC	dewpoint plus temperature
26CP-OTX-V1.xx.UIC	oxygen plus temperature
26CP-CTP-V1.xx.UIC	carbon potential plus temperature programmer
26CP-DTP-V1.xx.UIC	dewpoint plus temperature programmer
26CP-OTP-V1.xx.UIC	oxygen plus temperature programmer

These files are included in the iTools CD. iTools is the software which may be used for configuration of 2000 series instruments.

The order code for your controller is identified on a label fixed to the side of the instrument. This can be checked against the explanation of the order code given at the end of this supplement.

Instrument views shown in this handbook are typical but may vary in detail depending on the clone file loaded or the state of certain parameters.

1.1.1 Related Handbooks

For further details not described in this supplement please refer to the following handbooks where this symbol is shown :-

- 2604 Installation and Operation Handbook Part No. HA026491
- 2604 Engineering Handbook Part No. HA026761
- iTools User Handbook Part No. HA026179
- I/O Expander Handbook Part No. HA026893

All handbooks are available on the Eurotherm web site www.eurotherm.co.uk.

Select Documentation → Document Library DATABASE → Keyword (eg 2604) → Choose the handbook and DOWNLOAD. The documents are in pdf format.

1.2 WHAT IS CARBON POTENTIAL CONTROL

Carburizing may be used to provide a hard surface to steel after it has been formed. It is produced by placing the steel in a furnace with a carbon atmosphere and holding it at a temperature of between about 800 and 1100°C for a period of time.

As the carbon is absorbed into the steel the carbon potential controller will admit a carbon rich gas from an endothermic generator or air into the furnace atmosphere to maintain the desired carbon potential setpoint.

Carbon potential cannot be measured directly and so must be inferred using other measurements. The most common of these uses a Zirconia probe.

1.2.1 Zirconia Probe

The zirconia probe actually measures the oxygen content and generates a mV signal based on the ratio of oxygen concentration between the reference air side of the probe (outside the furnace) and the amount of oxygen actually inside the furnace. The temperature and the CO content of the furnace atmosphere are also measured and from all of these measurements the carbon content can be calculated. Each manufacturer of zirconia probes may use a different algorithm for calculating the carbon content and the 2604CP controller may be configured for the type in use.

1.2.2 Dewpoint

In this application the zirconia probe measures the actual dewpoint of the gas. For both oxygen and dewpoint measurement the CO level of the sample gas is assumed to be constant at 40%. The dewpoint is then directly related to the carbon content. An increasing dewpoint represents a decreasing carbon content.

The diagram below shows a typical 2604CP applied to the control of temperature and carbon in a furnace.

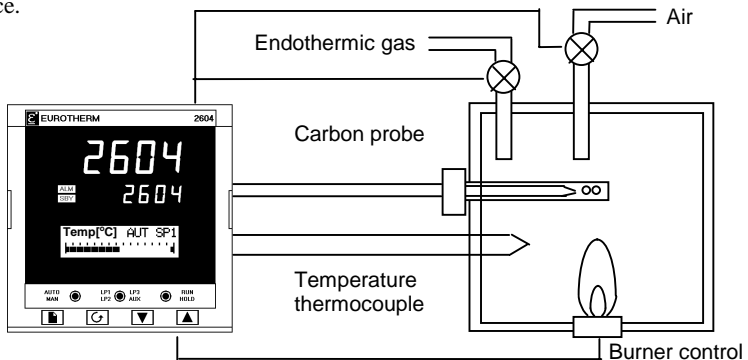

Figure 1-1: Temperature/Carbon Control Loop

1.2.3 Sooting Alarm and Probe Burn Off

Because of the harsh atmosphere in the furnace the probe can become contaminated. When this occurs the 2604CP initiates an alarm and this can turn on a solenoid to admit air down the ceramic tube of the probe. The air on the heated surface creates an intense burning action which cleans the tip of the probe. The burn off can also be initiated at regular intervals by the 2604CP controller and the duration of the admittance of the air can also be set.

1.3 TYPICAL FUNCTION BLOCK DIAGRAM

The block diagram below shows a simplified overview of the carbon potential controller when integrated with temperature programmer.

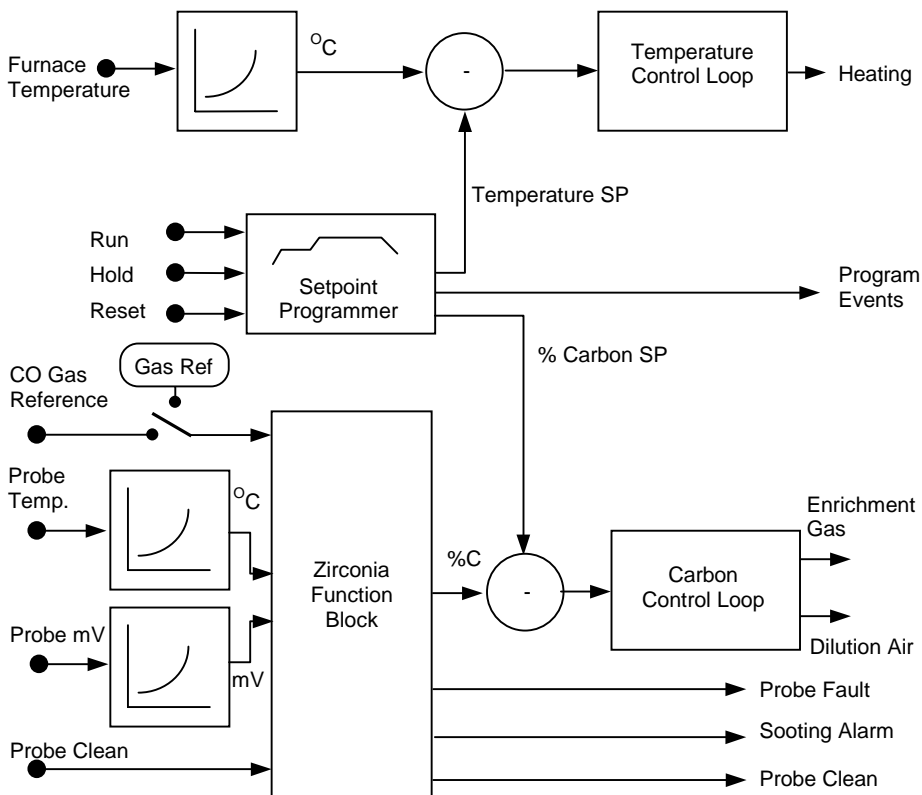

Figure 1-2: Typical Furnace Atmosphere Controller/Programmer Block Diagram

1.4 INSTALLATION

The 2604CP Furnace Atmosphere Controller/Programmer should be installed as described in Chapter 2 of the Installation and Operation Handbook.

WARNING



You must ensure that the controller is correctly configured for your application. Incorrect configuration could result in damage to the process being controlled, and/or personal injury. It is your responsibility, as the installer, to ensure that the configuration is correct. See 2604 Engineering Handbook for details.

1.5 WIRING CONNECTIONS

☞ **Before proceeding further, please read Appendix B, Safety and EMC information, in the above handbooks.**

This controller has the following configuration depending on the order code:-

- Temperature control loop, 50 single profile programs, four events
- Zirconia control loop (Carbon, Dewpoint, Oxygen)
- Toolkit functions including mathematical calculations, combination logic, real time clock, timer function
- Dual relay (part no. AH025246U002) or DC control output module (part no. AH025728U003) fitted in slot 1 provides temperature control output
- Dual relay output module (part no. AH025246U002) fitted in slot 3 provides programmer event outputs
- Dual relay output module (part no. AH025246U002) fitted in slot 4 provides time proportion outputs for both gas and air
- Analogue input module (part no. AH025728U002) fitted in slot 5 to provide dc retransmission
- Dual analogue input module (part no. AH026359) fitted in slot 6 provides temperature and probe input for the Zirconia sensor
- Optional communications module fitted in slot H
- Standard toolkit functions

The following connection diagrams are shown for the above configuration.

1.5.1 Controller Connections to Plant Devices

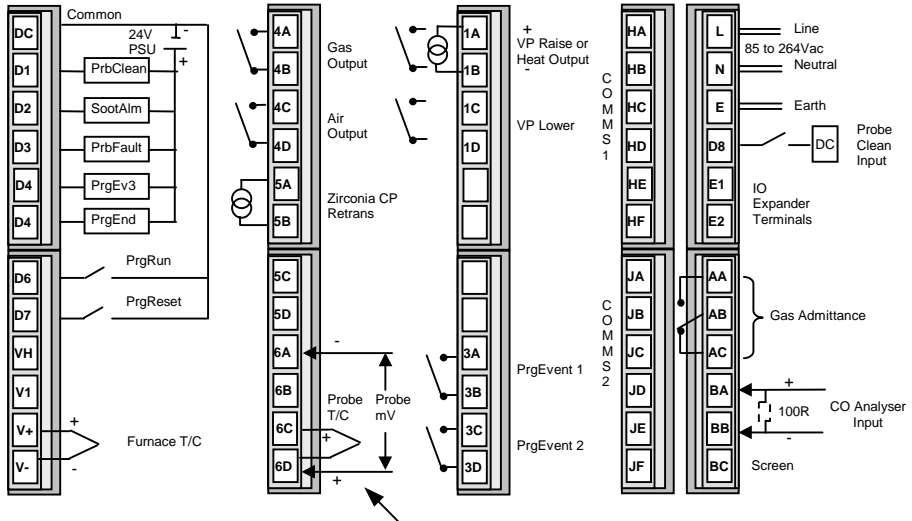

Note
 Thermocouple negative connected to 6D
 Probe positive connected to 6D

The Furnace thermocouple measures the temperature of the furnace

The Probe thermocouple measures the temperature at the zirconia probe

The Probe Thermocouple input and Probe mV input are not isolated from each other, although they are isolated from all other I/O.

Figure 1-3: Controller Terminals

1.5.2 IO Expander Connections to Plant Devices

☞ See IO Expander Handbook for further details.

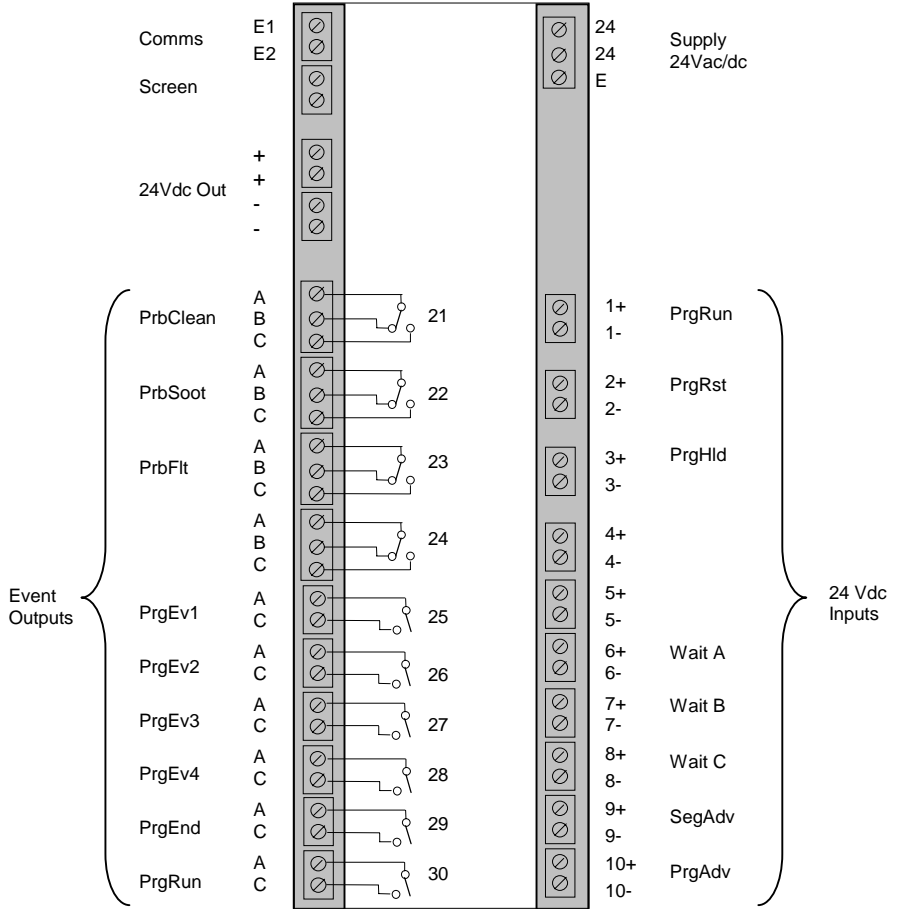

Figure 1-4: IO Expander Terminals

1.6 TEMPERATURE/ZIRCONIA CONTROL

Switch on the controller. After a brief self-test sequence, during which the controller displays the software version number, you will see an overview display. The display shown below is the overview for a temperature loop for a controller/programmer. The displays and operating procedures for carbon, dewpoint and oxygen are basically the same. Differences are highlighted where applicable.

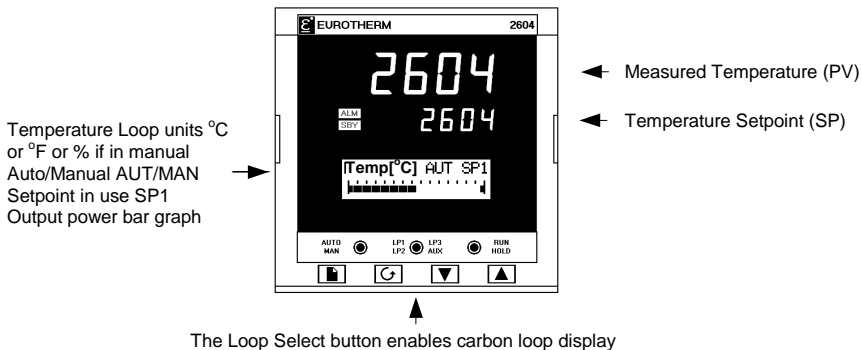

Figure 1-5: Temperature/Carbon Display

1.6.1 To Change Temperature Setpoint

From temperature loop view press or . The display will change to

Target SP
[°C] ◆ 200.0

Keep pressing or , to raise or lower the setpoint.

1.6.2 To Change to the Carbon Setpoint

From carbon loop view press or . The display will change to

Target SP
[%CP] ◆ 1.14

Keep pressing or , to raise or lower the setpoint.

1.6.3 To Select Auto or Manual Operation

From the temperature or carbon loop view, press . The AUTO beacon will change

Target OP
[%] ◆ 50.0

to MAN, and the display will now show

Press or to increase or decrease the output power.

The temperature and carbon loops can be put into manual independently.

1.6.4 Alarm Messages

If alarms occur the red ALM beacon will flash and an alarm message is shown in the lower readout, in the format shown below.

Press  to acknowledge as instructed. The red ALM beacon will light continuously if the alarm condition is still present but any relay connected to the alarm output will be reset. If the alarm condition is no longer present when it is acknowledged then both the red ALM beacon and a relay output will be reset.

Any further alarms will also need to be acknowledged before the overview can be seen.

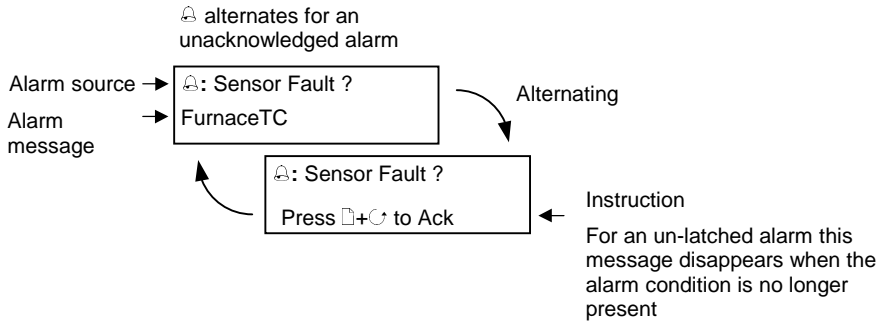
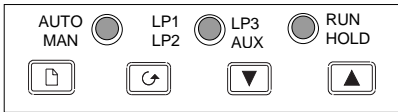

Figure 1-6: Alarm Message Banner

1.6.5 Operator Buttons









	<p>Auto/Manual button</p>	<p>When pressed, this toggles between automatic and manual mode:</p> <ul style="list-style-type: none"> ▪ If the controller is in automatic mode 'AUT' is displayed ▪ If the controller is in manual mode, 'MAN' is displayed <p>In manual mode the output power of either the temperature or carbon loops can be adjusted by the operator.</p>
	<p>Loop select button</p>	<p>Each press selects a different overview display <i>The overview name is shown in the banner at the top of the display</i></p>
	<p>Programmer button</p> <p>This button is only applicable if the programmer version is supplied</p>	<ul style="list-style-type: none"> • Press once to RUN a program • Press again to HOLD a program • Press again to toggle between RUN & HOLD • Press and hold for two seconds to RESET
	<p>Page button</p>	<p>Press to select the Page Headers.</p>
	<p>Scroll button</p>	<p>Press to select a new parameter from the page heading. If held down it will continuously scroll through the parameters.</p>
	<p>Down button</p>	<p>Press to decrease an analogue value, or to change the state of a digital value</p>
	<p>Up button</p>	<p>Press to increase an analogue value, or to change the state of a digital value</p>

Figure 1-7: Operator Buttons

1.7 SETPOINT PROGRAMMER

This section describes how to create, edit and run programs in controllers fitted with this option.

The programmer has two setpoint profiles for temperature and carbon, connected to control loops 1 and 2 respectively. Digital inputs are available for Run, Reset and Hold on IO expander inputs 1, 2 or 3. Run and Reset are also available on controller terminals D6 and D7. Four digital event outputs are pre-configured – more can be added by the user (see Engineering Handbook). Event outputs 1 and 2 are available on terminals 3A and 3C. Event 3 is available on D4 and event 4 is wired to start a probe clean cycle.

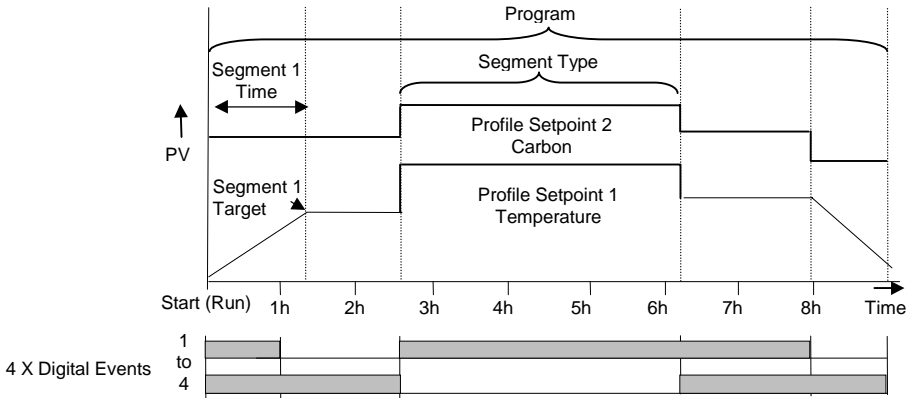

Figure 1-8: Example of a Carbon/Temperature Profile

1.7.1 Setpoint Programmer Block Diagram

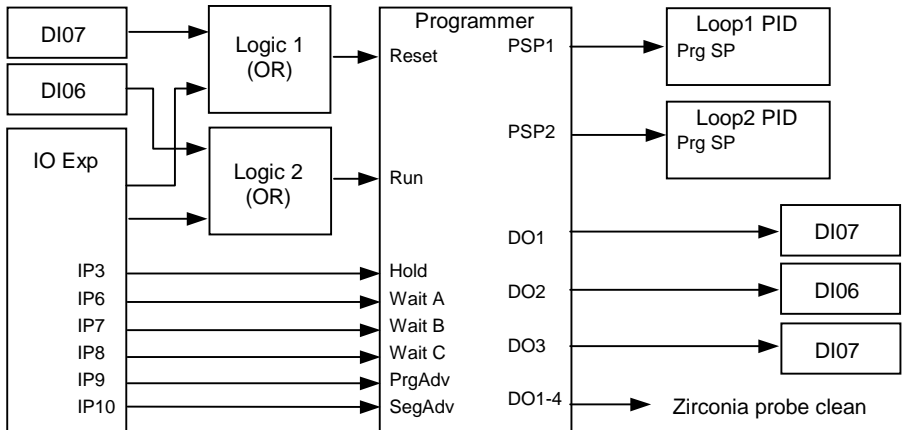

Figure 1-9: Programmer Block Diagram

1.7.2 Programmer Type











The programmer type is configured as Time to Target.

Each segment consists of a **single duration parameter** and a set of **target values** for the profiled variables.

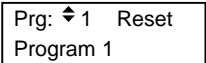
1. The **duration** specifies the time that the segment takes to change the profiled variables from their current values to the new targets.
2. A **dwell** type segment is set up by leaving the target setpoint at the previous value.
3. A **Step** type segment is set up by setting the segment time to zero.

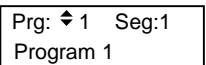
The operating descriptions which follow are specific to the 2604CP clone files. For a general description of operation refer to the 2604 Installation or Engineering Handbooks.

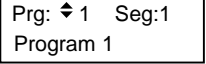
1.7.3 To Select, Run, Hold or Reset a Program

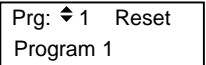









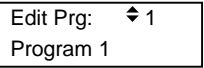

Do This	This Is The Display You Should See	Additional Notes
1. A program can be selected through the SUMMARY page or the PROGRAM RUN General Page 2. Using the SUMMARY page, press  3. Press  or  to select the program number	 	
4. To run the selected program, press  . Note 1		The green RUN beacon will illuminate. If the Loop view is selected the right hand message changes to show the program number being run e.g. PO1
5. To hold the selected program, press  . Note 2		The green HOLD beacon will illuminate.
6. To reset the selected program, press and hold  for at least 2 seconds. Note 3		The green RUN/HOLD beacon will extinguish.

Notes:-

1. In run the programmer varies the setpoint in accordance with the profile set in the active program.
2. In hold the programmer is frozen at its current point. In this state you can make temporary changes to program parameters such as a target setpoint and segment durations. Such changes can only be made in the current or subsequent segments and will only remain effective until the end of the currently running segment, when they will be overwritten by the stored program values.
3. In reset the programmer is inactive and the controller behaves as a standard controller, with the setpoint determined by the raise/lower buttons.
4. A list of parameters available for a running program is available under the page header PROGRAM RUN. Refer to section 1.7.9.
5. External run, reset or hold inputs are available on the IO Expander. If this has been supplied and wired to external buttons then the program may be operated from these buttons.

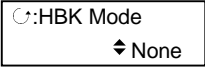
1.7.4 To Create or Edit a Program

The programmer parameters are grouped under page headings in exactly the same way as other parameters.

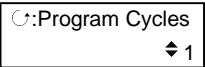









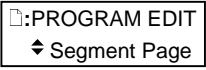





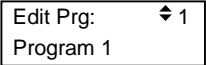

Do This	This Is The Display You Should See	Additional Notes
1. From any display press  as many times as necessary to ' PROGRAM EDIT '		This is access level 1 view
2. Press  to edit the program number 3. Press  or  to select the program to be edited		
4. Press  to edit the next parameter. This is ' HBK Mode ' 5. Press  or  to change the holdback type		The choices are:- None Per Program Per Segment (see also Note 1 section 1.7.7.)
6. Continue to press  to select parameters to be edited and  or  to change their values		









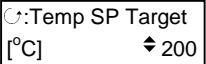



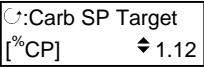

Continue to select parameters and to change their values as described above. The following table shows the full list of parameters in this page together with a description of their functions.

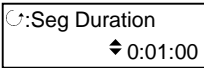
1.7.5 PROGRAM EDIT (Program Page) Parameters





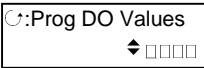

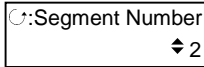
Table Number: 1.7.5.		These parameters affect the overall program. All parameters are available at Level 1. To hide parameters refer to the Engineering Handbook	PROGRAM EDIT (Program Page)
Parameter Name	Parameter Description	Value	Default
Program Number	Selects the program number to be edited.	1 to 50	1
Hbk Mode See also Note 1 in section 1.7.7.	Holdback mode None = no holdback Per prog = applied over the whole program Per seg = active in every segment	None Per Program Per Segment	Per Segment
Temp SP HBk Type Only displayed if Per Program configured	Holdback type for Temperature program These are deviations between SP and PV Fine and course holdback allows two levels of holdback to be applied to different segments.	Off Fine Lo Fine Hi Fine Band Course Lo Course Hi Course Band	Off
Carb SP HBk Type Only displayed if Per Program configured	Holdback type for Carbon/Oxygen/Dewpoint program These are deviations between SP and PV Fine and course holdback allows two levels of holdback to be applied to different segments.	Off Fine Lo Fine Hi Fine Band Course Lo Course Hi Course Band	Off
Program Cycles	The number of times a program repeats.	Cont. to 999	Cont.
End Action	Defines the conditions for the end segment. Dwell - the program will dwell indefinitely at the conditions set in the end segment. Reset - the program will reset to the start conditions.	Dwell Reset	
Program Name	Allows the name of the program to be customised		Program 1

1.7.6 To Set Up Each Segment of a Program

Do This	This Is The Display You Should See	Additional Notes
1. From any display press  to access 'PROGRAM EDIT'		This is access level 1 view
2. Press  or  to select 'Segment Page'	3. Press  to show the first parameter in this page 4. Press  or  to select the program to be edited	If the program exists, the segment details are displayed If the program selected is new, confirm as instructed on the display 
5. Press  to edit the 'Segment Number'	 	If the segment selected is new, confirm as instructed on the display. Not applicable to segment 1  Up to 100 segments are available per program
6. Press  or  to change the segment number if necessary	7. Press  to edit the 'Segment Type'	The choices are:- Profile Go Back End Segment See the PROGRAM EDIT (Segment) Parameter tables for an explanation
8. Press  or  to select the segment type	9. If the segment type is Profile the next parameter is 'Temp SP Target' 10. Press  or  to set the temperature to ramp to in this segment	 

<p>11. Press  to scroll to and edit 'Carb SP Target'</p> <p>12. Press  or  to select the target value in this segment</p>		<p>Carbon/Oxygen/Dewpoint parameters will only be shown if this option has been supplied</p>
<p>13. Press  to edit 'Seg Duration'</p> <p>14. Press  or  to select the time taken for the segment to complete</p>		<p>By default the programmer is configured as a time to target program in which all profile segments are set up as time periods</p> <p>Tip ☺:- Press  and  to select minutes or hours independently. These can then be changed without the need to scroll through the complete mins/seconds range</p>
<p>15. Press  to edit the 'Prog DO Values'</p> <p>16. Press  or  to select <input type="checkbox"/> or <input checked="" type="checkbox"/></p>		<p>Up to four digital outputs can be set to operate in each segment. If the IO Expander is being used these outputs switch relays to operate external devices.</p> <p><input type="checkbox"/> = Off in the selected segment <input checked="" type="checkbox"/> = On in the selected segment</p>
<p>17. Press  to scroll to and edit the next 'Segment Number'</p> <p>18. The above steps can now be repeated for all remaining segments required for the selected program number</p>		

Tip ☺ A back and forward scroll is available by holding down  and pressing  or  respectively

<p>19. Press  to scroll to and edit the 'Temp SP HBk Type'</p> <p>20. Press  or  to select the type of holdback which is to apply to the chosen segment</p> <p>21. Holdback may also be set separately for Carbon</p>	<p style="text-align: center;">Holdback Type</p> <div style="border: 1px solid black; padding: 5px; margin: 10px auto; width: fit-content;"> :Temp SP HBk Ty  Fine Lo </div> <div style="border: 1px solid black; padding: 5px; margin: 10px auto; width: fit-content;"> :Carb SP HBk Ty  Fine Lo </div>	<p>If 'Holdback Type' has been configured in the PROGRAM EDIT Program Page as Holdback per Segment then each segment will contain a holdback parameter</p> <p>A full explanation of Holdback Type is given in the following section Note 1.</p> <p>The choices are:-</p> <p>Off</p> <p>Fine Lo</p> <p>Fine Hi</p> <p>Fine Band</p> <p>Course Lo</p> <p>Course Hi</p> <p>Course Band</p>
--	--	---

Carbon/Dewpoint/Oxygen Programmer

The three or four parameters which follow are to set up the program segment for the carbon, dewpoint or oxygen controller depending on which clone file has been supplied.

They are set up using the same procedure as described above.

Further Segments

Up to 100 segments can be set up in any program. Scroll back to 'Segment Number' and select the next segment. Then repeat the procedure above.

The following table gives a summary of all parameters which appear in the Program Edit list.

1.7.7 PROGRAM EDIT (Segment) Parameters

Table Number: 1.7.7.		These parameters allow you to set up each segment in the program	PROGRAM EDIT (Segment Page)	
Parameter Name	Parameter Description	Value	Default	
Edit Prog	Selects the program number to be edited. If the program name has been customised this name will be shown here	1 to 50		
Segment Number	Selects the segment number to be edited	1 to 100		
Segment Type	Segment type	Profile End Segment Go Back	Profile	
	Profile = a segment which has a time period End Segment = the last segment in the program (press  to confirm) Go Back = repeat part of program. Not shown for segment 1.			
Temp SP Target	The temperature which the program is heading for in the selected segment	Temp lo limit to Temp hi limit	0 –1200°C	
Temp HBk Type	Temperature holdback type Not shown if Segment Type = End Segment A full description of holdback is given in Note 1 after this table	Off Fine Lo Fine Hi Fine Band Course Lo Course Hi Course Band	Off	
The following three parameters only appear if Carbon, Oxygen or Dewpoint is configured				
Carbon/Oxygen/ Dewpoint SP Target	The Carbon Potential/ Oxygen/Dewpoint value which the program is heading for	PSP2 lo limit to PSP2 hi limit	0	
Carbon/Oxygen/ Dewpoint SP HBk Type	Holdback type for the application in use Not shown if Segment Type = End Segment A full description of holdback is given in Note 1 after this table	Off Fine Lo Fine Hi Fine Band Course Lo Course Hi Course Band	Off	
Seg Duration	The time taken for the segment to go from its previous temp/carbon value to the new target	0:00:00 to 500:00:00		
Prog DO Values	Sets programmer event outputs on or off	<input type="checkbox"/> /■ = Off/On in the selected segment	4	

Note 1 Holdback Type defines how holdback operates. It may apply when:

- The PV is below the SP by a pre-set value (Lo),
- The PV is above the SP by a pre-set value(Hi)
- The PV is below or above the SP by a pre-set value (Band).

In addition two levels of holdback are available per profile setpoint, per program. These are defined as 'Fine' and 'Course'.

Holdback freezes the program if the process value does not track the setpoint by an amount which can be set by the user.

During a period when the setpoint is changing it indicates that the process value is lagging the setpoint by more than a pre-set amount and that the program is waiting for the process to catch up.

During a period when the setpoint is constant it will freeze the time if the difference between SP and PV exceeds pre-set limits.

In both cases it guarantees the correct time period for the product.

Holdback (PROGRAM EDIT Program page) may be configured in three modes:

- OFF - holdback does not operate
- Applied to the complete program. Holdback operates the same way in every segment
- To each individual segment. A different holdback type can be applied to each segment

Example:

Holdback, operating in each segment, is often used in a temperature control application as detailed below:-

During a 'ramp up' period the holdback type may be set to deviation low. If the Process Value lags the programmed rate of rise, holdback will stop the program until the PV catches up. This prevents the set program from entering the next segment until the PV has attained the correct temperature.

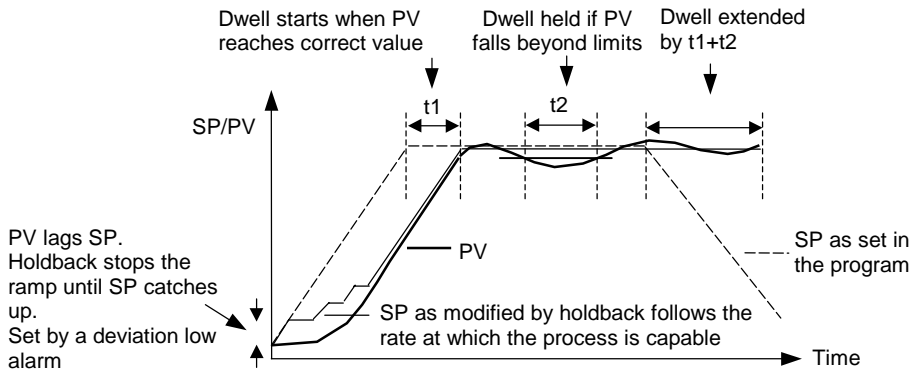

Figure 1-10: Effect of Holdback to Produce Guaranteed soak







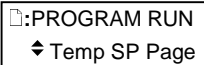

1.7.8 To Edit A Running Program

From time to time it may be necessary to make temporary changes to the currently running program, for example, to change the target setpoint or to add time to a segment. The current running program can only be edited under the following conditions:-

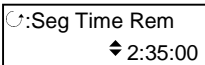
- The program must be put into ‘Hold’
- Changes to the currently running segment are temporary and apply only to the current run
- Permanent changes should be made in the ‘PROGRAM EDIT’ pages, see previous section.
- Other programs can be created or edited when another program is running

1.7.8.1 Example: To Change Current Segment Time or Target Setpoint

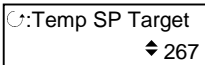
Place the program in ‘Hold’. Then:-

Do This	This Is The Display You Should See	Additional Notes
1. Select the ‘PROGRAM RUN (Temp SP)’ page		Alternatively select the Carbon/Oxygen/Dewpoint Page
2. Press  to select the first parameter in the list of parameters for the running temperature program. This is ‘Seg Time Rem’		These adjustments can be made to the current segment and allow temporary changes to be made to the current run
3. Press  or  to extend or reduce the time remaining in the current segment		
4. Press  to scroll to ‘Temp SP Target’		Temp Target can be set between the high and low limits set in configuration level, see Engineering Handbook
5. Press  or  to increase or decrease the temperature target in the current segment		

Now place the programmer in Run

1.7.9 Run Parameters

General Page

Table Number: 1.7.9.		These parameters show the state of a running program. All parameters are available at Level 1. To hide parameters refer to the Engineering Handbook	PROGRAM RUN (General Page)	
Parameter Name	Parameter Description	Value	Default	
Prg: 1 Seg: 1 Program 1	Summary of number of running program, current segment and customised name of program. If the programmer is reset, this is shown in place of Seg: x			
Prg: 1 Seg: 1 ◆ □□□□	Summary of number of running program, current segment and state of digital event outputs			
Prg: 1 Seg: 1 16:05:05	Summary of number of running program, current segment and time remaining in current segment			
Program Status	Shows the status of the program	Run Reset Hold		
Prog Cycles Rem	Remaining number of cycles before the program is complete	1 to 999	Only shown if 'Prog Cycles' > 1	
Total Segments	Number of segments in the running program	0 to 100	R/O	
Segment Number	The number of the current segment	1 to 100		
Segment Type	The current segment type	Profile End Segment Go Back	R/O	
Seg Time Rem	Time remaining in the current segment	h:m:s		
End Action	The state set in the end segment	Dwell Reset	R/O	
Prog Reset DO	The state of the digital events in reset □/■ = Off/On in the segment	□□□□		

Temp Page

Table Number: 1.7.9.		These parameters show the state of the temperature parameters in a running program. All parameters are available at Level 1. To hide parameters refer to the Engineering Handbook		PROGRAM RUN (Temp SP Page)	
Parameter Name	Parameter Description	Value	Default		
Seg Time Rem	Time remaining in the current segment	hrs:mins:secs			
Temp SP	The current segment temperature				
Temp SP Target	The current target temperature				
Temp SP HBk Appl	Holdback applied in the current segment	No Yes			R/O

Carbon, Oxygen or Dewpoint Page







If the variable being controlled is Carbon Potential, Oxygen or Dewpoint a separate page is available which list the running parameters for this variable. The type of variable depends on the particular clone file loaded.

The parameters are the same as those listed above for temperature but the term temperature is replaced by the name of the variable (carbon, oxygen or dewpoint).

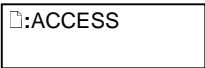
1.8 ACCESS

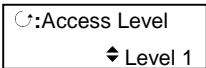
In normal operation the controller will start up in Level 1. This gives access to parameters which have been described in previous sections. In certain cases, for example when commissioning the controller, it may be necessary to gain access to further parameters.

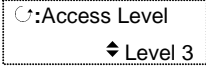
1.8.1 To Select Access Level 3

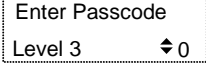
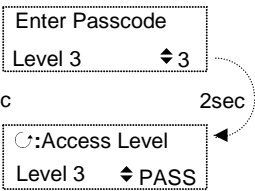
Do This	This Is The Display You Should See	Additional Notes
<p>1. From any display press  as many times as necessary until the ACCESS page header is displayed</p>		
<p>2. Press  to select Access Level</p>		
<p>3. Press  or  to select the required access level. E.g. Level 3</p>		
<p>4. Press  or  to enter the passcode.</p>		<p>The default passcode of a new controller is 3 to enter level 3. If a new passcode has been previously entered it will be in the form 0 to 9999.</p>
<p>5. When the correct passcode is entered the display momentarily changes to PASS, then back to the start level to confirm correct entry.</p>		<p>If an incorrect passcode is entered, the display returns to 0.</p>
		<p>Note: In the special case that the passcode has been configured as 'None', the display will blink momentarily when Level 3 is selected and Level 3 will be entered immediately</p>







1.9 ALARMS

The following alarms have been configured:-

Name	Type	Description
Admit Gas	Full scale high event	Triggered when the temperature measured by the probe exceeds a set value (default 760°C for carbon). Delay 10 seconds
High Impedance	Full scale high	Alarm to indicate probe failure Delay 10 seconds
High Z Inhibit	Full scale high event	Inhibits the High Impedance alarm when the probe temperature is below 800°C
Sooting Alarm	Full scale high	Triggered by the zirconia probe sooting alarm delay 10 seconds
Recovery Fault	Full scale high	Triggered by the zirconia status

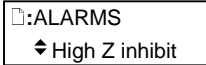
1.9.1 To Activate/Deactivate Alarms

Any of the above alarms may be activated or deactivated **in operating Level 3**. The following example deactivates the High Z Inhibit alarm:-











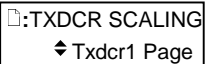

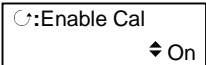

Do This	This Is The Display You Should See	Additional Notes
<p>2. Select the 'ALARMS' page</p> <p>3. Press  or  to scroll to the alarm which you wish to activate/deactivate. In this case 'High Z Inhibit'</p>		<p>This is an access level 3 view</p>
<p>4. Press  as many times as necessary to scroll to 'Inhibit'</p> <p>5. Press  or  to select 'Yes' or 'No'</p>		

1.10 PROBE IMPEDANCE

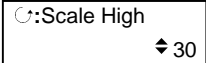
When the output impedance of a zirconia probe increases above a certain level, it indicates that the performance of the probe has deteriorated, and should be replaced. The 2604CP controller has the ability to measure the impedance of the sensor connected to its input, and in conjunction with User Alarms an alarm strategy created to alert the operator.

1.10.1 To Calibrate High Impedance Input

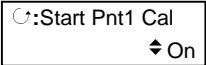
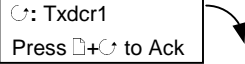
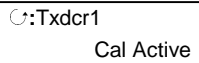
This can only be done in Level 3.

Do This	This Is The Display You Should See	Additional Notes
<p>1. With the probe disconnected, place a resistor value 30KΩ across the input terminals 6A and 6D</p> <p>2. From any display press  as many times as necessary until the 'TXDCR SCALING' page header is displayed.</p>		<p>The value of the resistor is not critical but the 'Cal High(kohm)' value must be set to the chosen resistor value.</p> <p>This value is measured by the parameter 'Probe kohm' in the following procedure</p>
<p>3. Press  to edit 'Enable Cal'</p> <p>4. Press  or  to 'On'</p>		
<p>5. Press  to scroll to 'Scale High'</p> <p>6. Press  or  to '30' to correspond to the resistor chosen</p>		
<p>7. Press  to scroll to 'Start Point 1 Cal'</p> <p>8. Place a short circuit across the resistor</p> <p>9. Press  or  to 'On'</p>	<p>Calibrate the Low Point</p>   	<p>Press  +  as directed to start the zero point calibration.</p> <p>When this has been completed the 'On' message reverts to 'Off'</p>

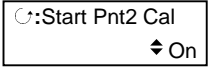
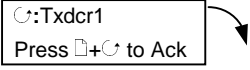
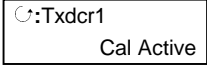
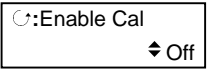
Calibrate the High Point		
<p>10. Remove the shorting link and replace with the 30KΩ calibration resistor</p>		<p>Press + as directed to start the zero point calibration.</p>
<p>11. Press to scroll to 'Start Pnt2 Cal'</p>		<p>When this has been completed the 'On' message reverts to 'Off'</p>
<p>12. Press to select 'On'</p>		<p>If the calibration fails, due for example to an incorrect value of calibration resistor being used, then the message:-</p>
<p>13. Remove the calibration resistor and re-connect the probe</p>		<div style="border: 1px solid black; padding: 5px; width: fit-content; margin: 5px auto;"> <p style="text-align: center;">Txdcr1 Failed Press + to Ack</p> </div> <p>will appear</p>
<p>14. Press again to scroll to 'Enable Cal'</p>		<p>High Z impedance is now calibrated such that 0-100% = 0-30KΩ</p>
<p>15. Press or to 'Off'</p>		

Set the Probe Impedance Failure Threshold

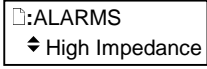
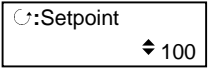
<p>16. Press to select the 'ALARMS' header and or to 'High Impedance'</p>		
<p>17. Press to scroll to 'Setpoint'</p>		<p>In this view the probe impedance is set to 100KΩ. If the probe impedance exceeds this value an alarm is produced</p>
<p>18. Press or to adjust if necessary</p>		

1.10.2 Alarm Inhibition

Zirconia probes have an extremely high impedance at lower temperatures. For this reason the probe temperature measurement is used to inhibit alarms at temperatures below 850°C.

1.10.3 Impedance Measurement Filter

The probe impedance measurement is inherently noisy. The 2604CP uses a Toolkit block to apply internal filtering to the input.

1.11 ORDERING CODE

1	2	3	4	5	6	7	8	9	10	11	12	13	14
---	---	---	---	---	---	---	---	---	----	----	----	----	----

1. Controller Type	
2604CP	2604 Standard
2604CPF	2604 Profibus

2. Supply Voltage	
VH	85-264Vac
VL	20-29Vac/dc

3. Controller Function	
CXX	Carbon
DXX	Dewpoint
OXX	Oxygen
DTX	Dewpoint/Temp
OTX	Oxygen/Temp
CTX	Carbon/Temp
CTP	Carbon/Temp Programmer
DTP	Dewpoint/Temp Programmer
OTP	Oxygen/Temp Programmer

4. Furnace Control Sensor	
X	Unconfigured
K	Type K
N	Type N
R	Type R
S	Type S
B	Type B

5. Temp Control Output	
XX	Not Fitted
TP	Time proportioning
VP	Valve position
OF	On/Off
4mA20	4-20mA
0mA20	0-20mA
0V10	0-10Vdc
0V5	0-5Vdc
1V5	1-5Vdc

6. Zirconia Probe Type	
MV	Probe millivolts
DP	Dewpoint
OX	% Oxygen
OP	PPM Oxygen
BC	Barber Colman
DR	Drayton
MC	MMI Carbon
MD	MMI Dewpoint
AC	Accucarb
SS	SSI
MD	Macdhui
AA	AACC
BH	Bosch Carbon
BO	Bosch Oxygen

7. Probe Thermocouple	
X	Unconfigured
K	Type K
N	Type N
R	Type R
S	Type S
B	Type B

8. Gas Control Output	
TP	Time proportioning
OF	On/Off

9. Zirconia Retransmission	
XX	Not Fitted
4mA20	4-20mA
0mA20	0-20mA
0V10	0-10Vdc
0V5	0-5Vdc
1V5	1-5Vdc

10. CO Analyser Input	
XX	Not Fitted
4mA20	4-20mA
0mA20	0-20mA
0V10	0-10Vdc
0V5	0-5Vdc
1V5	1-5Vdc

11. H Comms Slot	
XX	Not Fitted
A2	232 Modbus
Y2	2-wire 485 Modbus
F2	4-wire 485 Modbus
AE	232 Bisynch
YE	2-wire 485 Bisynch
FE	4-wire 485 Bisynch
PB	Profibus
DN	Devicenet

12. J Comms Slot	
XX	Not Fitted
A2	232 Modbus
Y2	2-wire 485 Modbus
F2	4-wire 485 Modbus
M1	232 Master
M2	2-wire 485 Master
M3	4-wire 485 Master

13. Toolkit Blocks	
XX	Standard
U1	Toolkit Level 1
U2	Toolkit Level 2

14. Manual	
ENG	English
FRA	French
GER	German

1.11.1 Ordering Code for the IO Expander

