

T757X SERIES

- **Typical capacity is up to 512 I/O points per enclosure**
- **The services enclosure supports up to 4 I/O enclosures**
- **Standard construction and minimum wiring reduces cost**
- **Floor standing**
- **Front and rear access option for increased packing density**
- **Supplied tested and documented including drawings**
- **Protected up to IP54**
- **Top and bottom cable entry**



Control Enclosure Specification Sheet

The T757X series of standard enclosures comprises of one services enclosure and between one and four I/O enclosures bayed to form a single suite. Each I/O enclosure has been designed to accommodate up to ten T2550 16-way Process Automation Controllers. The pre-configured design keeps build time and implementation costs to a minimum and all active components are easily removable to facilitate maintenance.

Careful attention has been given to redundant power distribution and network to provide a high degree of fault tolerance. As an option an Eycon™ Visual Supervisor can be mounted on the front door as a local operator interface.

I/O Terminations

Integral Terminal Units on the T2550 base provide the connection between the plant wiring and the T2550 PAC I/O modules. As there is no direct wiring to the plug in I/O modules, they can be replaced under power without any disturbance to the field wiring. Isolator links or fuses are options for certain modules.

Any required terminals can be mounted on the terminal rail provided.

High Integrity Power Supply System

All control units are powered by 24V dc for simplicity and safety. The 24V dc is provided by several PSUs in redundant configuration, powered from the System ac mains.

Network Connections

Internal communications between the various control nodes is via high speed Ethernet based control network.

Optional external Modbus and Profibus communications are available.

System Availability

High availability of the system is assured by the fundamental reliability of the control units and redundant CPU options, plus the following features built into the enclosure design:

- Redundant power supplies
- Hot swap replacement of all active components
- Extensive health monitoring and diagnostics with indicator LEDs/watchdog relays prewired
- Electrical/control segregation
 - Separate services enclosure ensures electrical distribution segregated from signal wiring
 - Easy field cable distribution and within trunking (top/bottom entry)
- Easy field signal interface
 - Optionally a range of DIN rail mounted signal conditioning modules may be fitted
- Easy expandability
 - Start with one and expand up to 4 I/O enclosures per services enclosure

Documentation

The enclosures are supplied with standard drawings available on disk in AutoCAD format.

Customised Enclosures

Enclosures may be customised to accommodate additional equipment or variants in wiring standards but this will require a specific detailed quotation and incur an engineering charge.

Support Services

Eurotherm Customer Services Department offers a variety of onsite support services, including verification of network wiring and assistance with commissioning.

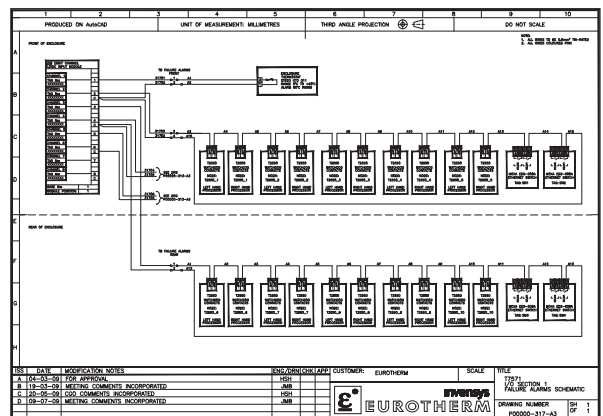
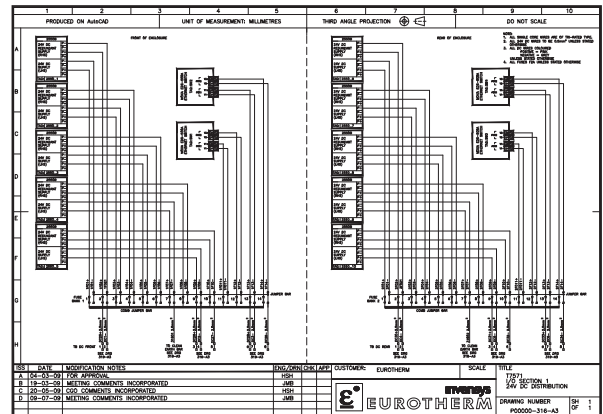
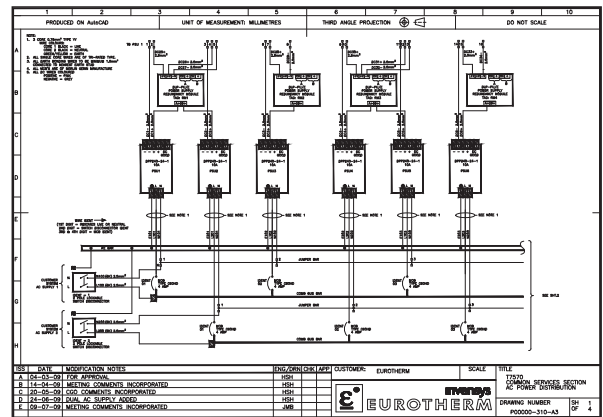

SPECIFICATION

Physical (version dependent)

	Services T7570	I/O Enclosure T7571
External dimensions (mm):	800W x 600D x 2000H	1000W x 600D x 2000H
Plinth - 100 (mm):	Yes	Yes
Weight (approx):	260kg	320kg
Cable entry - Top/Bottom	Yes/Yes	Yes/Yes
Door hinge - Left/Right	Left	Both
Light:	Yes	Yes
Thermostat (set at 50 degrees):	Yes	Yes
N+1 (redundant) PSU:	Yes	Yes
Inlet fan/filter:	Yes	Yes
Internal equipment T2550 16 way:		Yes
'External' alarms pre-wired (DI8 in 1st base, 1st position):	Yes	10
Protection category:	IP54	Yes
		IP54

Power supplies

System mains supply:	90-264V ac RMS
Input frequency:	47-63Hz
Auxiliary mains supply:	115 or 230V ac
Input frequency:	47-63Hz
Health status:	Green LED plus relay (N.O.) monitoring each PSU

General/environmental

Storage temperature:	-25°C to +85°C
Operating temperature:	0-35°C (0-50°C inside enclosure)
Relative humidity:	5 to 95% (non-condensing)
Design standards	
Protection:	BS EN60529
Electrical, mechanical:	IEC1131-2
Safety:	EN60204-1
CE	Conforms to EMC Directive 89/336/EEC and Low Voltage Directive 72/23/EEC

**T757X ENCLOSURE SUITE OVERVIEW
(2 I/O Enclosures)**

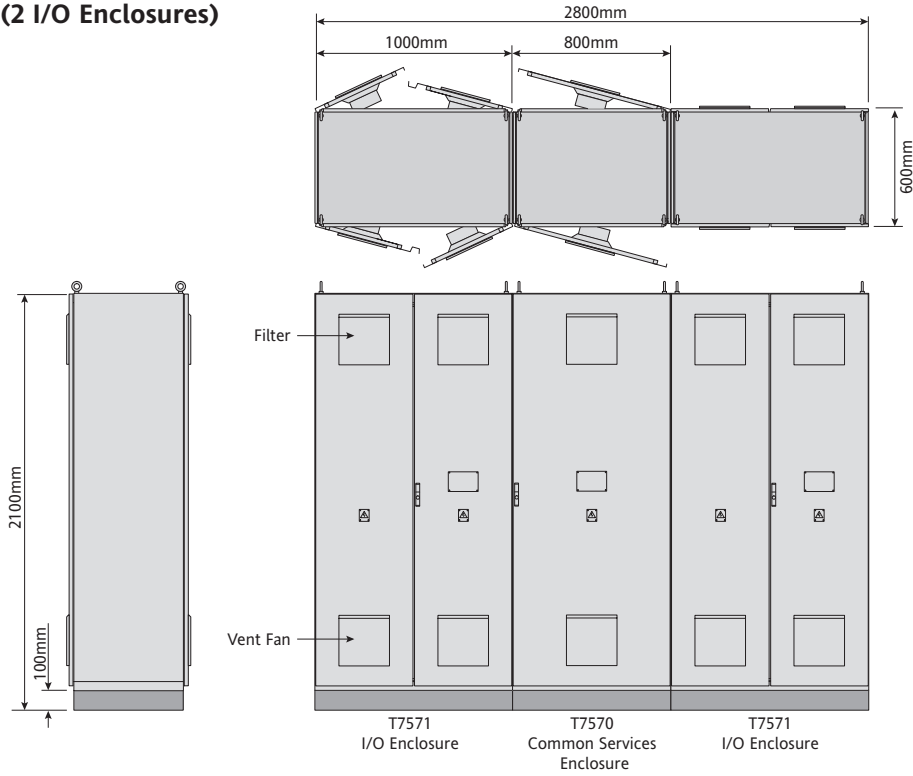

**T757X ENCLOSURE SUITE OVERVIEW
(4 I/O Enclosures)**

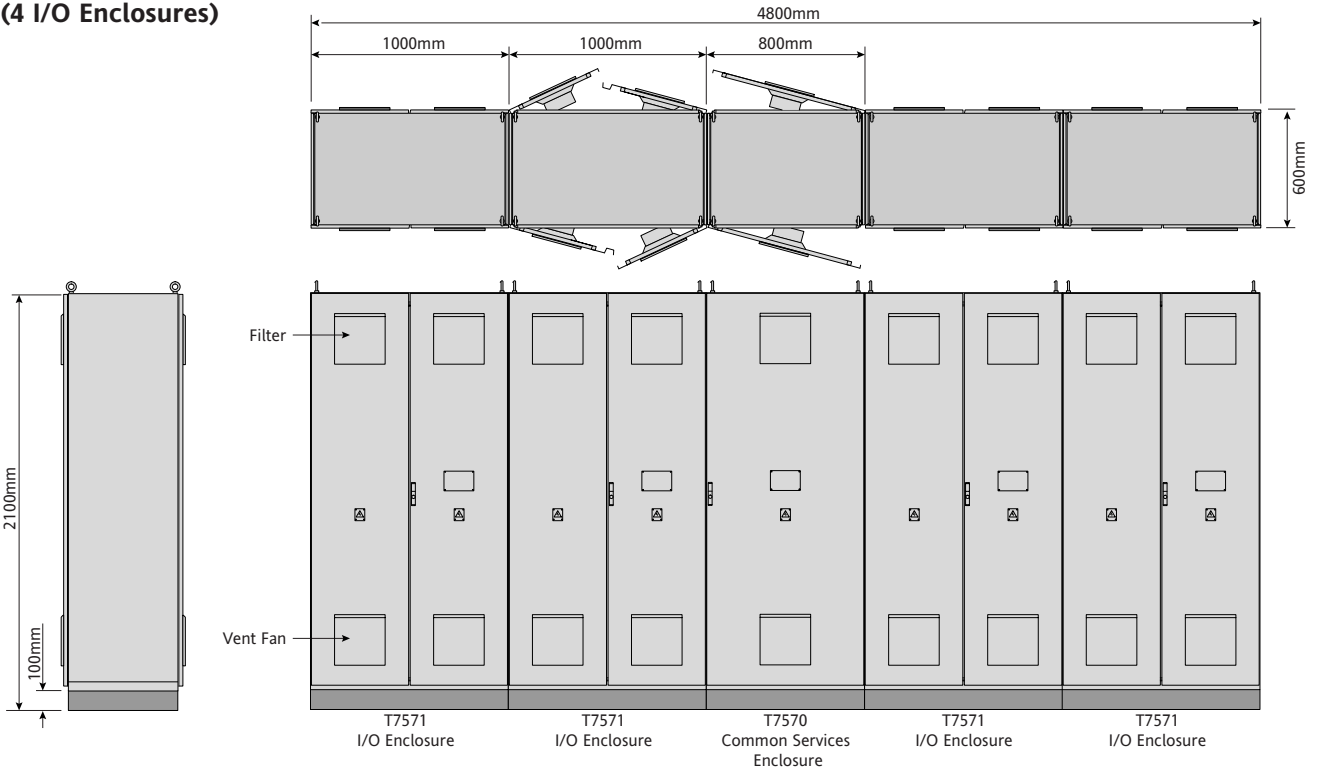

T2550 DIMENSIONS

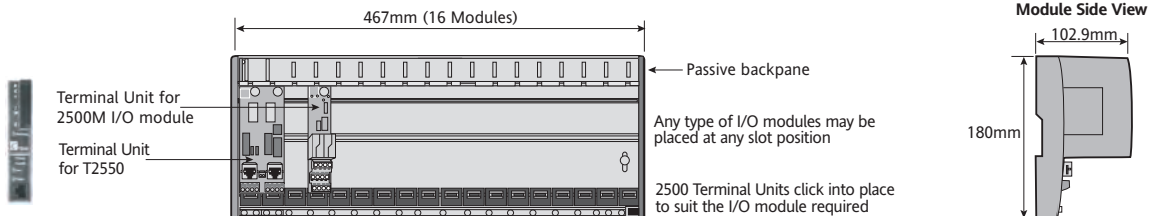

INSTALLATION DETAILS

General arrangement – This is a 2 I/O enclosure system

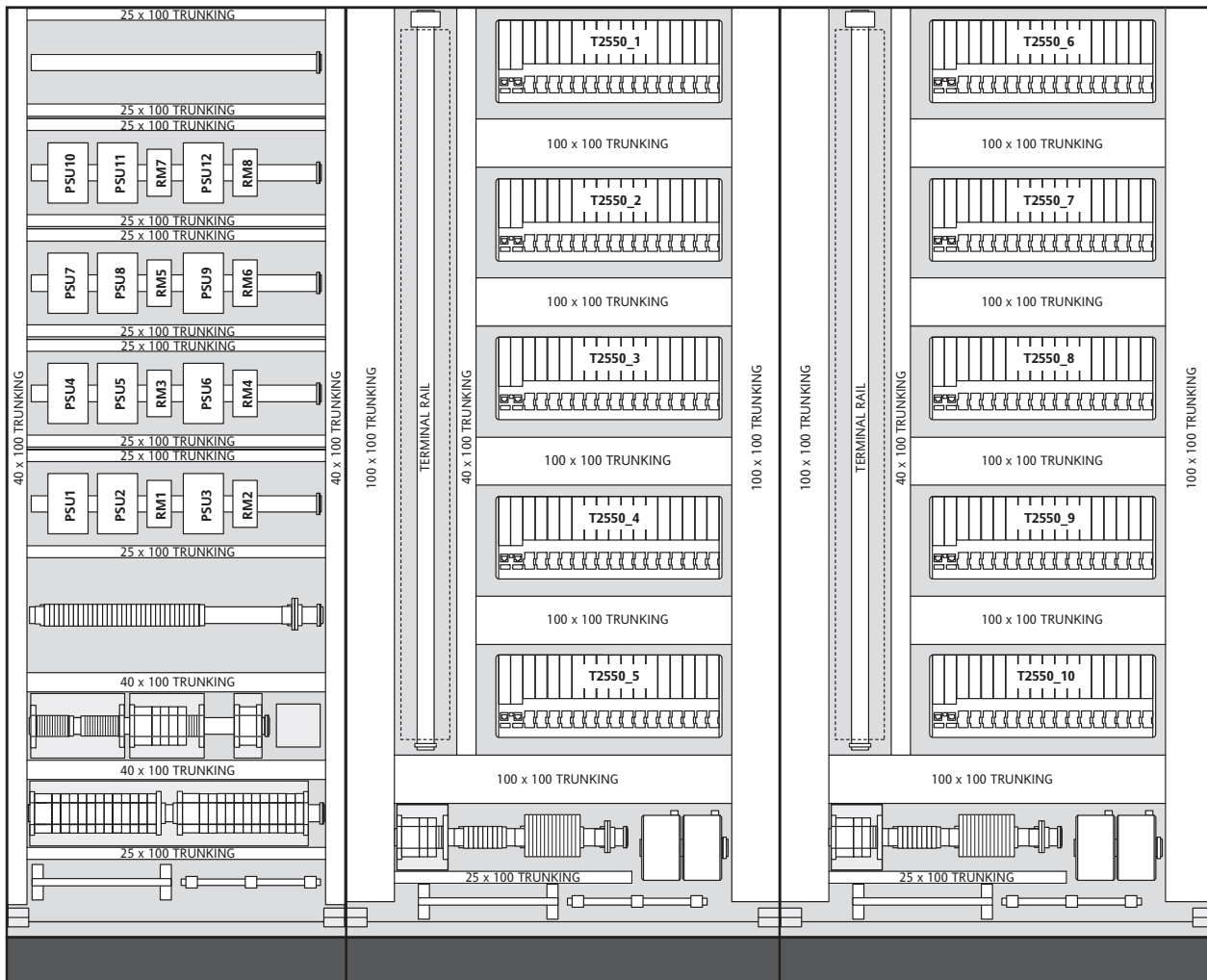

Eurotherm: International sales and service

AUSTRALIA Sydney
Eurotherm Pty. Ltd.
T (+61 2) 9838 0099
E info.au@eurotherm.com

AUSTRIA Vienna
Eurotherm GmbH
T (+43 1) 7987601
E info.at@eurotherm.com

BELGIUM & LUXEMBOURG Moha
Eurotherm S.A./N.V.
T (+32) 85 274080
E info.be@eurotherm.com

BRAZIL Campinas-SP
Eurotherm Ltda.
T (+5519) 3707 5333
E info.br@eurotherm.com

CHINA
Eurotherm China
T (+86 21) 61451188
E info.cn@eurotherm.com
Beijing Office
T (+86 10) 84585757
E info.cn@eurotherm.com
Guangzhou Office
T (+86 20) 38106506
E info.cn@eurotherm.com

DENMARK Copenhagen
Eurotherm Danmark AS
T (+45 70) 234670
E info.dk@eurotherm.com

FINLAND Abo
Eurotherm Finland
T (+358) 22506030
E info.fi@eurotherm.com

FRANCE Lyon
Eurotherm Automation SA
T (+33 478) 664500
E info.fr@eurotherm.com

GERMANY Limburg
Eurotherm Deutschland GmbH
T (+49 6431) 2980
E info.de@eurotherm.com

HONG KONG
Eurotherm Hongkong
T (+85 2) 28733826
E info.hk@eurotherm.com

INDIA Chennai
Eurotherm India Limited
T (+91 44) 24961129
E info.in@eurotherm.com

IRELAND Dublin
Eurotherm Ireland Limited
T (+353 1) 4691800
E info.ie@eurotherm.com

ITALY Como
Eurotherm S.r.l.
T (+39 031) 975111
E info.it@eurotherm.com

KOREA Seoul
Eurotherm Korea Limited
T (+82 31) 2738507
E info.kr@eurotherm.com

NETHERLANDS Alphen a/d Rijn
Eurotherm B.V.
T (+31 172) 411752
E info.nl@eurotherm.com

NORWAY Oslo
Eurotherm A/S
T (+47 67) 592170
E info.no@eurotherm.com

POLAND Katowice
Invensys Eurotherm Sp z o.o.
T (+48 32) 2185100
E info.pl@eurotherm.com

SPAIN Madrid
Eurotherm España SA
T (+34 91) 6616001
E info.es@eurotherm.com

SWEDEN Malmo
Eurotherm AB
T (+46 40) 384500
E info.se@eurotherm.com

SWITZERLAND Wollerau
Eurotherm Produkte (Schweiz) AG
T (+41 44) 7871040
E info.ch@eurotherm.com

UNITED KINGDOM Worthing
Eurotherm Limited
T (+44 1903) 268500
E info.uk@eurotherm.com
www.eurotherm.co.uk

U.S.A. Leesburg VA
Eurotherm Inc.
T (+1 703) 443 0000
E info.us@eurotherm.com
www.eurotherm.com

ED58

© Copyright Eurotherm Limited 2009

Invensys, Eurotherm, the Eurotherm logo, Chessell, EurothermSuite, Mini8, Eycon, Eyris, EPower and Wonderware are trademarks of Invensys plc, its subsidiaries and affiliates. All other brands may be trademarks of their respective owners.

All rights are strictly reserved. No part of this document may be reproduced, modified, or transmitted in any form by any means, nor may it be stored in a retrieval system other than for the purpose to act as an aid in operating the equipment to which the document relates, without the prior written permission of Eurotherm limited.

Eurotherm limited pursues a policy of continuous development and product improvement. The specifications in this document may therefore be changed without notice. The information in this document is given in good faith, but is intended for guidance only.

Eurotherm Limited will accept no responsibility for any losses arising from errors in this document.

